

**carolus** 



**Atelier  
&  
Garage**

**Liste de prix  
2014  
Prijslijst**



4



5 > 7



8 > 9



10 > 11



13 > 17



18 > 23



24 > 25



26 > 31

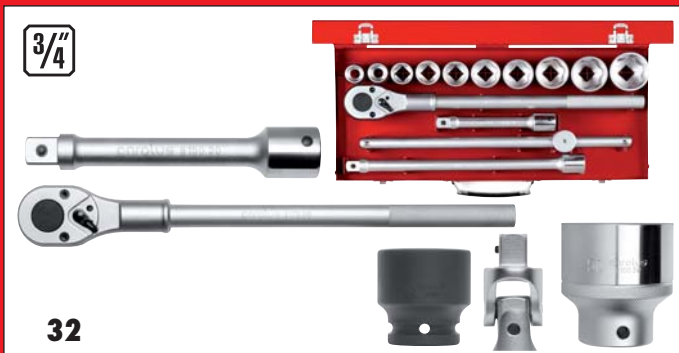

32

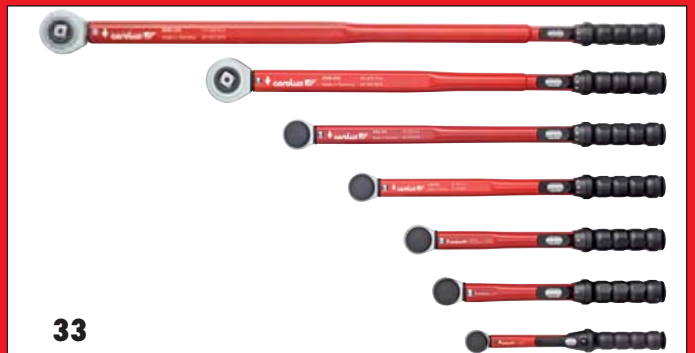

33



**34 > 37**



**38 > 39**

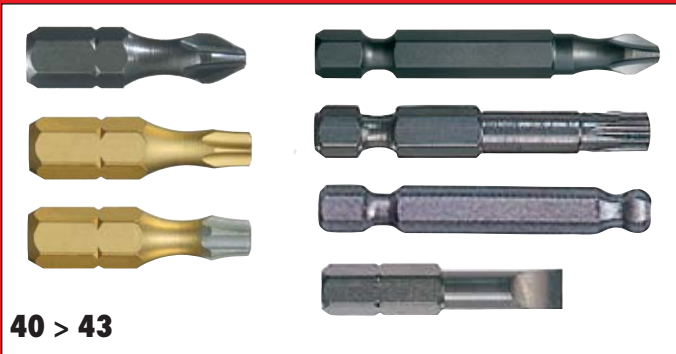

**40 > 43**



**44 > 45**



**46 > 49**



**50 > 51**

**52 > 53**



**54 > 57**



**58 > 59**

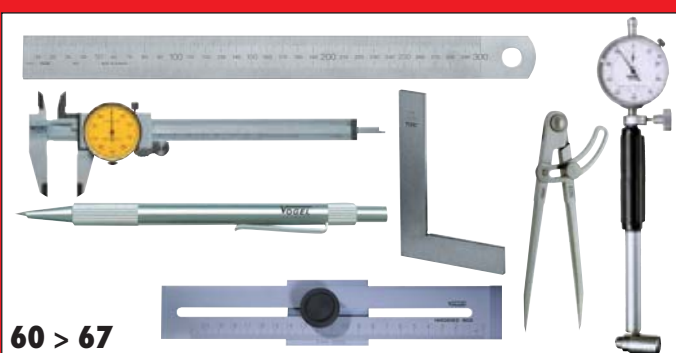

**60 > 67**



**68 > 74**



### Servante 6 tiroirs à ouverture totale et blocage individuel

- 4 tiroirs 482 x 345 mm - Hauteur 69 mm
- 1 tiroir 482 x 345 mm - Hauteur 144 mm
- 1 tiroir 482 x 345 mm - Hauteur 218 mm
- Capacité de charge: 25 kg par tiroir
- Fermeture centralisée par cylindre à clé
- Deux roues orientables Ø 100 mm, dont l'une avec frein et deux roues fixes Ø 140 mm
- Panneaux latéraux perforés pour accessoires
- Dimensions: 628 x 410 mm - H 910 mm
- Capacité de charge: 210 kg

### Gereedschapswagen met 6 volledig uittrekbare laden en lade-uittrekbeveiliging

- 4 laden 482 x 345 mm - Hoogte 69 mm
- 1 lade 482 x 345 mm - Hoogte 144 mm
- 1 lade 482 x 345 mm - Hoogte 218 mm
- Laadcapaciteit: 25 kg per lade
- Centrale vergrendeling door cilinderslot met sleutel
- 2 zwenkwielen Ø 100 mm, waarvan 1 met rij- en zwenkblokkering en 2 bokwielen Ø 140 mm
- Geperforeerde zijwanden voor accessoires
- Afmetingen: 628 x 41 mm - H 910 mm
- Laadcapaciteit: 210 kg

Code	Ref.	€
2835940	<b>2046.10</b>	<b>510,00</b>



### Servante 7 tiroirs à ouverture totale et blocage individuel

- 5 tiroirs 570 x 410 mm - Hauteur 83 mm
- 2 tiroirs 570 x 410 - Hauteur 155 mm
- Chaque tiroir avec tapis anti-slip
- Verrouillage centralisé par clé
- Capacité de charge: 35 kg par tiroir
- 1 panneau latéral perforé pour accessoires, l'autre équipé d'un support pour rouleau de papier et d'une boîte
- Large poignée de chaque côté
- Deux roues orientables Ø 125 mm, dont l'une avec frein et deux roues fixes
- Dimensions: 724 x 470 mm - H 1034 mm
- Capacité de charge: 450 kg

### Gereedschapswagen met 4 volledig uittrekbare laden en lade-uittrekbeveiliging

- 5 laden 570 x 410 mm - Hoogte 83 mm
- 2 laden 570 x 410 mm - Hoogte 155 mm
- Elke lade met anti-slipmat
- Centrale vergrendeling met sleutel
- Laadcapaciteit: 35 kg per lade
- 1 geperforeerde zijwand voor accessoires, andere zijwand voorzien van papierrrolhouder en afvalbak
- Brede greep langs beide zijden
- 2 zwenkwielen Ø 125 mm, waarvan 1 met rij- en zwenkblokkering en 2 bokwielen
- Afmetingen: 724 x 470 mm - H 1034 mm
- Laadcapaciteit: 450 kg.

Code	Ref.	€
2857448	<b>2057.10</b>	<b>660,00</b>





**Jeu de clés polygonales en module 1/3**  
**Ringsleutelset in 1/3 module**

6x7 8x9 10x11 12x13 14x15 16x17 18x19 20x22 mm

Code	Ref.	€
1928996	<b>2020.91</b>	<b>43,00</b>



**Jeu de clés plates en module 1/3**  
**Steeksleutelset in 1/3 module**

6x7 8x9 10x11 12x13 14x15 16x17 18x19 20x22 mm

Code	Ref.	€
1929003	<b>2020.92</b>	<b>26,00</b>



**Jeu de clés mixtes en module 2/3**  
**Ringsteeksleutelset in 2/3 module**

6 7 8 9 10 11 12 13 14 15 16 17 18 19 21 22 24 mm

**Clé mâles coudées / Haakse stiftsleutels**

2 2,5 3 4 5 6 8 10 mm

Code	Ref.	€
2266911	<b>2020.710</b>	<b>79,50</b>



**Jeu de clés mixtes à cliquet en module 2/3**  
**Ringratel-steeksleutelset in 2/3 module**

8 9 10 11 12 13 14 15 16 17 18 19 20 21 22 mm

**Clé mâles coudées / Haakse stiftsleutels**

2 2,5 3 4 5 6 8 10 mm

Code	Ref.	€
2266938	<b>2020.711</b>	<b>193,00</b>



**Jeu de clés mixtes à cliquet en module 1/3**  
**Ringratel-steeksleutelset in 1/3 module**

8 10 12 13 14 15 16 17 19 mm

Code	Ref.	€
2656442	<b>2020.709</b>	<b>125,00</b>



**Jeu de clés mixtes à tête polygonale articulée à cliquet en module 1/3**  
**Gewricht-ringratelsteeksleutelset in 1/3 module**

8 10 12 13 14 15 16 17 18 19 mm

Code	Ref.	€
2266970	<b>2020.714</b>	<b>168,00</b>

**Jeu de douilles 1/4" et accessoires en module 1/3  
Doppenset 1/4" en toebehoren in 1/3 module**

- ⊖ 4 4.5 5 5.5 6 7 8 9 10 11 12 13 mm
- ⊗ TXB10 TXB15 TXB20 TXB25 TXB27 TXB30 TXB40
- 3 4 5 6 8 10 mm - ⊖ 5.5 6.5 mm
- ⊕ Ph1 Ph2 Ph3 - ⊕ Pz1 Pz2

Code	Ref.	€
1986732	<b>2020.85</b>	<b>102,00</b>

**Cliquet 1/2" et accessoires en module 1/3  
Ratel 1/2" en toebehoren in 1/3 module**

- Cliquet / Ratel 5190.20
- Poignée coulissante / Schuifgreep 5140,00
- Cardan / Cardangewricht 5130,00
- Allonges / Verlengstuk 125 mm - 250 mm

Code	Ref.	€
1929062	<b>2020.97</b>	<b>54,50</b>

**Jeu de douilles 1/2" en module 1/3  
Doppenset 1/2" in 1/3 module**

- ⊖ 10 11 12 13 14 15 16 17 18 19 21 22 23 24 26 27 28 30 32 mm
- 6 7 8 9 10 12 14 mm

Code	Ref.	€
1929054	<b>2020.96</b>	<b>91,00</b>

**Jeu de douilles-tournevis 1/2" en module 1/3  
Dopschroevendraaierset 1/2" in 1/3 module**

- 60 mm 5 6 7 8 9 10 12 14 17 mm
- 80 mm 5 6 8 mm
- 140 mm 10 12 14 mm

Code	Ref.	€
2267020	<b>2020.718</b>	<b>85,00</b>

**Jeu de douilles à choc 1/2" en module 1/3  
Slagdoppenset 1/2" in 1/3 module**

- ⊖ 10 11 12 13 14 15 16 17 19 21 22 24 mm

Code	Ref.	€
2267039	<b>2020.719</b>	<b>91,00</b>

**Marteau et outils de frappe en module 1/3  
Hamer en beiterset in 1/3 module**

- Marteau d'ajusteur 300 g / Bankhamer 300 g
- Burin plat / Vlakbeitel 125 mm - 150 mm
- Bedane / Ritsbeitel 125 mm - Chasse-clous / Doorslag Ø 3 mm
- Chasse-goupilles / Pendrijver Ø 4 mm - Pointeau / Centerpons Ø 4 mm

Code	Ref.	€
1929038	<b>2020.94</b>	<b>28,50</b>



**Jeu de pinces en module 1/3**  
**Tangenset in 1/3 module**

Pince multiprise 10" / Waterpomptang 10"  
Pince universelle 180 mm / Kombinatietang 180 mm  
Pince téléphone 160 mm / Telefoontang 160 mm  
Pince coupantediagonale 160 mm / Zijsnijtang 160 mm

Code	Ref.	€
1929011	<b>2020.93</b>	<b>55,00</b>



**Jeu de pinces pour circlips en module 1/3**  
**Set borgringtangen in 1/3 module**

Extérieur droit / Buiten recht 19-60 mm  
Extérieur coudé / Buiten gebogen 19-60 mm  
Intérieur droit / Binnenkant recht 19-60 mm  
Intérieur coudé / Binnenkant gebogen 19-60 mm

Code	Ref.	€
2267152	<b>2020.724</b>	<b>53,00</b>



**Jeu de Tournevis en module 1/3**  
**Schroevendraaier set in 1/3 module**

⊖ 4 5.5 6.5 8 mm  
⊕ Ph1 Ph2

Code	Ref.	€
1929046	<b>2020.95</b>	<b>24,00</b>



**Jeu de Tournevis en module 1/3**  
**Schroevendraaier set in 1/3 module**

⊖ 4 5.5 6.5 8 mm  
⊕ Pz1 Pz2

Code	Ref.	€
2267047	<b>2020.720</b>	<b>24,00</b>



**Jeu de Tournevis en module 1/3**  
**Schroevendraaier set in 1/3 module**

⊕ T10 T15 T20 T25 T30 T40

Code	Ref.	€
2267101	<b>2020.721</b>	<b>24,00</b>



**Jeu de Tournevis VDE en module 1/3**  
**VDE-schroevendraaier set in 1/3 module**

⊖ 4 5.5 6.5 8 mm  
⊕ Ph1 Ph2

Code	Ref.	€
2267144	<b>2020.723</b>	<b>26,00</b>



### Pince universelle

- Acier au chrome-molybdène, finition chromée

### Combinatietang

- Chroom-molybdeen staal, satijn verchromd

Code	Ref.	↳ mm	€
2247720	<b>2830.180</b>	180	<b>15,70</b>
2247739	<b>2830.200</b>	200	<b>17,90</b>



### Pince coupante diagonale modèle américain

- Acier au chrome-molybdène, finition chromée

### Zijsnijtang Amerikaans model

- Chroom-molybdeen staal, satijn verchromd

Code	Ref.	↳ mm	€
2247798	<b>2840.180</b>	180	<b>18,90</b>
2247801	<b>2840.200</b>	200	<b>21,10</b>



### Pince coupante diagonale modèle suédois

- Acier au chrome-molybdène, finition chromée

### Zijsnijtang Zweeds model

- Chroom-molybdeen staal, satijn verchromd

Code	Ref.	↳ mm	€
2247763	<b>2845.160</b>	160	<b>14,60</b>



### Pince téléphone à bec droit

- Acier au chrome-molybdène, finition chromée

### Telefoontang met rechte bek

- Chroom-molybdeen staal, satijn verchromd

Code	Ref.	↳ mm	€
2247828	<b>2850.160</b>	160	<b>14,60</b>
2247836	<b>2850.200</b>	200	<b>15,70</b>



### Pince téléphone à bec coudé

- Acier au chrome-molybdène, finition chromée

### Telefoontang met gebogen bek

- Chroom-molybdeen staal, satijn verchromd

Code	Ref.	↳ mm	€
2247844	<b>2851.200</b>	200	<b>17,90</b>



### Pince multiprise à ajustement automatique Waterpomp tang automatisch instelbaar

Code	Ref.	↳ mm	€
2247909	<b>2815.10</b>	250	<b>20,00</b>





**Pince-étau - en acier nickelé**  
**Griptang - vernikkeld staal**

Code	Ref.	mm	l mm	€
2247925	<b>2820.07</b>	35	185	<b>9,50</b>
2247941	<b>2820.10</b>	40	225	<b>10,70</b>
2247968	<b>2820.12</b>	60	295	<b>15,00</b>



**Pince-étau à long bec - en acier nickelé**  
**Griptang met lange bek - vernikkeld staal**

Code	Ref.	mm	l mm	€
2247976	<b>2822.065</b>	50	175	<b>9,60</b>
2247984	<b>2822.09</b>	70	215	<b>10,70</b>



**Pince multiprise à branches entre passées**  
**Waterpomptang met doorgestoken handvatten**

Code	Ref.	l mm	€
1680854	<b>2010.10</b>	250	<b>9,80</b>



**Clé serre-tubes - forme S**  
**Pijptang - S-vorm**

Code	Ref.	l inch	l mm	€
1892215	<b>2179.10</b>	1	325	<b>18,30</b>
1892223	<b>2179.15</b>	1.1/2	420	<b>26,90</b>
1892231	<b>2179.20</b>	2	535	<b>40,50</b>
1892258	<b>2179.30</b>	3	640	<b>75,50</b>



**Clé à molette - chromée**  
**Schroef sleutel - verchromd**

Code	Ref.	mm	l mm	€
2246422	<b>0300.06</b>	20	155	<b>8,50</b>
2246457	<b>0300.08</b>	25	205	<b>10,70</b>
2246465	<b>0300.10</b>	30	255	<b>13,90</b>
2246473	<b>0300.12</b>	36	305	<b>17,20</b>



**Clé à sangle - 215 mm**  
**Bandsleutel - 215 mm**

Code	Ref.	l mm	Ø mm	€
1680862	<b>0450.00</b>	570	140	<b>14,10</b>
1782312	<b>0450.01</b>	Sangle de rechange Losse band		<b>8,50</b>



**Clé en croix pour voiture**  
**Kruissleutel voor personenwagens**

- Dimensions:
- Afmetingen: 17 x 19 (3/4") x 21 x 11/16"

Code	Ref.	€
1683233	<b>0400.00</b>	<b>20,90</b>



### Couteau universel

- Poignée ergonomique multi matière: aluminium, ABS, TPR
- Livré avec 5 lames

### Universeel mes

- Ergonomische meercomponenten handgreep: aluminium, ABS, TPR
- Geleverd met 5 mesjes.

Code	Ref.		€
2250519	<b>9100.00</b>		<b>12,90</b>
2524775	<b>9100.05</b>	10 lames de rechange 10 vervangmesjes	<b>4,00</b>



### Cutter 10 mm

- Livré avec 5 lames
- Geleverd met 5 mesjes

Code	Ref.		€
1855018	<b>9111.00</b>		<b>2,40</b>
1855026	<b>9111.11</b>	10 lames de rechange 10 vervangmesjes	<b>0,80</b>



### Cutter 18 mm

- Livré avec 5 lames
- Geleverd met 5 mesjes

Code	Ref.		€
1825038	<b>9110.00</b>		<b>4,00</b>
1825046	<b>9110.10</b>	10 lames de rechange 10 vervangmesjes	<b>1,90</b>



### Cutter 25 mm

- Avec clip pour ceinture
- Livré avec 5 lames
- Met gordelclip
- Geleverd met 5 mesjes

Code	Ref.		€
1880071	<b>9112.00</b>		<b>8,60</b>
1880098	<b>9112.12</b>	10 lames de rechange 10 vervangmesjes	<b>4,60</b>



### Mètres roulants CE Classe II

- Boîtier ergonomique en ABS
- Ruban en acier avec couverture nylon contre l'abrasion
- Retour automatique avec frein
- Crochet avec aimant

### Rolbandmaten EG Klasse II

- Ergonomisch doosje uit ABS
- Staallint met beschermende nylonlaag tegen slijtage
- Automatische terugkeer met rem
- Haak met magneet

Code	Ref.	L m	mm	€
2250373	<b>9534.03</b>	3	19	<b>4,10</b>
2250381	<b>9534.05</b>	5	19	<b>5,10</b>
2250403	<b>9534.08</b>	8	25	<b>8,50</b>



**Scie multifonctions**

- Coupe affleurant possible par positionnement de la lame à 90°
- Etrier pouvant pivoter sur 180° en cas d'espace réduit

**Multifunctionele beugelzaag**

- Zaagblad op 90° zwenkbaar voor perfect effen zaagvlak
- Beugel 180° draaibaar om in geringe hoogte te kunnen werken

Code	Ref.	€
2250497	<b>9150.00</b>	<b>20,40</b>



Dents avoyées  
Geschrankt zaagblad

Easy start  
system

Master TDA	HSS-Co	Easy Start System	
Ref.	Type	V.E.	€
<b>TDA</b>	24 dts/pouce - 24 T/duim	100	<b>1,80</b>



**Scie multi-usages**

- Monture en aluminium, robuste et légère
- Pour la coupe de métaux divers et plastique

**Beugelzaag alle gebruik**

- Montuur in aluminium, licht en stevig
- Zaagblad voor verschilde materialen (metalen, kunststof)

Code	Ref.	€
2268124	<b>9130.000</b>	<b>10,80</b>
2665204	<b>9130.001</b>	<b>2,20</b>



**MINI COUPE-TUBES**

- Pour tubes en cuivre 3-22 mm

**MINI PIJPSNIJDER**

- Voor koperpijp 3-22 mm

Code	Ref.	€
2256061	<b>9228.416</b>	<b>11,80</b>
2524724	<b>9228.229</b>	<b>18,30</b>
	5 molettes de coupe	
	5 snijwieltjes	



**COUPE-TUBES**

- Pour tubes en cuivre 3-35 mm

**PIJPSNIJDER**

- Voor koperpijp 3-35 mm

Code	Ref.	€
2256088	<b>9229.335</b>	<b>33,40</b>
2524724	<b>9228.229</b>	<b>18,30</b>
	5 molettes de coupe	
	5 snijwieltjes	

**Forets à métaux HSS  
Metaalboren HSS**

DIN 338 type N

En coffret métal / in metalen kistje

Code	Ref.	€
2250713	<b>9700.019</b> - Ø 1-10 mm x 0.5 mm	<b>11,20</b>
2250721	<b>9700.025</b> - Ø 1-13 mm x 0.5 mm	<b>21,10</b>

**Outils de frappe en coffret métal  
Slaggereedschap in metalen kistje**

Chasse goupilles / Pendrijvers Ø 3 4 5 6 7 8 mm

Code	Ref.	€
1696823	<b>9410.00</b>	<b>18,50</b>

Chasse-clous / Doorslagen Ø 1 2 3 4 5 10 mm

Code	Ref.	€
1696831	<b>9420.00</b>	<b>18,90</b>

**Coffre à outils**

- Qualité polypropylène
- Inclus 4 boîtes à compartiments pour petites pièces et un grand rangement sous le couvercle
- Supporte un poids de 150 kg et peut donc servir de siège ou d'esca-beau
- Dimensions: 420 x 303 mm - Hauteur 400 mm

**Gereedschapskoffer**

- Koffer in polypropyleen
- Bestaat uit 4 sorteerdoosjes voor kleine stukken en een grote berg-ruimte onder het deksel
- Kan 150 kg dragen en mag dus als stoeltje gebruikt worden
- Afmetingen: 420 x 303 mm - Hoogte 400 mm

Code	Ref.	€
2247674	<b>2032.00</b>	<b>103,00</b>



**Clés plates** suivant DIN 3110, ISO 3318, ISO 1085, ISO 10102

- Acier au chrome-Vanadium, chromé

**Steeksleutels** volgens DIN 3110, ISO 3318, ISO 1085, ISO 10102

- Chrom-Vanadium staal, verchromd

Code	Ref.	Ø mm	l mm	V.E.	€
1655833	<b>0506.07</b>	6 x 7	122	10	<b>2,30</b>
1655841	<b>0508.09</b>	8 x 9	140	10	<b>2,30</b>
1655868	<b>0510.11</b>	10 x 11	157	10	<b>2,80</b>
1655876	<b>0510.13</b>	10 x 13	172	10	<b>3,20</b>
1655884	<b>0512.13</b>	12 x 13	172	10	<b>3,20</b>
1846531	<b>0513.14</b>	13 x 14	178	10	<b>3,60</b>
1655892	<b>0513.15</b>	13 x 15	188	10	<b>3,90</b>
1655906	<b>0513.17</b>	13 x 17	205	10	<b>3,90</b>
1655914	<b>0514.15</b>	14 x 15	188	10	<b>3,90</b>
1655930	<b>0516.17</b>	16 x 17	205	10	<b>3,90</b>
1655949	<b>0517.19</b>	17 x 19	222	10	<b>4,40</b>
1655957	<b>0518.19</b>	18 x 19	222	10	<b>4,40</b>
1655965	<b>0519.22</b>	19 x 22	236	10	<b>5,20</b>
1655973	<b>0520.22</b>	20 x 22	236	10	<b>5,20</b>
1655981	<b>0521.23</b>	21 x 23	247	10	<b>5,30</b>
1656015	<b>0522.24</b>	22 x 24	250	10	<b>5,90</b>
1656023	<b>0524.26</b>	24 x 26	266	10	<b>6,40</b>
1656031	<b>0524.27</b>	24 x 27	266	10	<b>6,70</b>
1656058	<b>0525.28</b>	25 x 28	280	10	<b>7,80</b>
1846574	<b>0527.30</b>	27 x 30	302	10	<b>10,20</b>
1656066	<b>0527.32</b>	27 x 32	302	10	<b>10,20</b>
1656074	<b>0530.32</b>	30 x 32	302	10	<b>10,20</b>
1846582	<b>0532.36</b>	32 x 36	328	10	<b>19,20</b>
1656104	<b>0536.41</b>	36 x 41	380	10	<b>24,80</b>

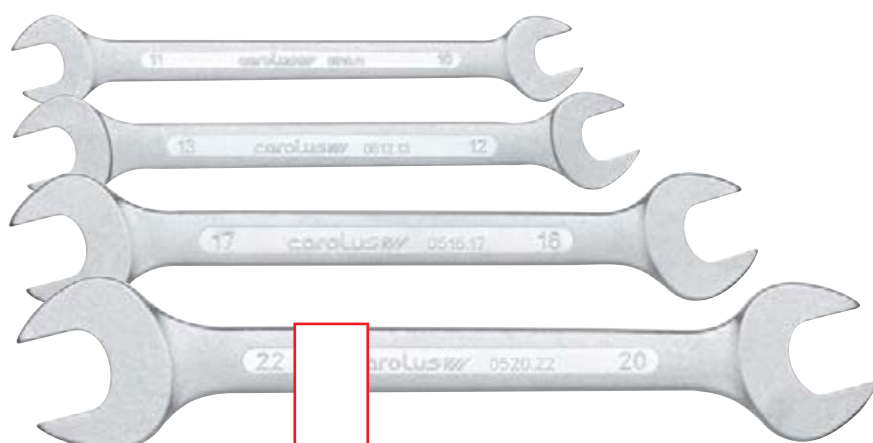

**Sets**

**Jeux de clés plates  
Steeksleutelsets**

Code	Ref.	Contenu / Inhoud	€
1694324	<b>0500.08</b>	6x7 8x9 10x11 12x13 14x15 16x17 18x19 20x22	<b>27,00</b>
1694359	<b>0500.100</b>	6x7 8x9 10x11 12x13 14x15 16x17 18x19 20x22 24x27 30x32	<b>44,00</b>
1694375	<b>0500.120</b>	6x7 8x9 10x11 12x13 14x15 16x17 18x19 20x22 21x23 24x27 25x28 30x32	<b>52,00</b>

**Clés polygales** suivant DIN 838, ISO 3318, ISO 1085, ISO 10104

- Acier au chrome-Vanadium, chromé

**Ringsleutels**

volgens DIN 838, ISO 3318, ISO 1085, ISO 10104

- Chrom-Vanadium staal, verchromd

Code	Ref.	Ø mm	l mm	V.E.	€
1655574	<b>0106.07</b>	6 x 7	170	10	<b>4,20</b>
1655582	<b>0108.09</b>	8 x 9	182	10	<b>4,20</b>
1655590	<b>0110.11</b>	10 x 11	195	10	<b>4,40</b>
1655604	<b>0110.13</b>	10 x 13	212	10	<b>4,90</b>
1655612	<b>0112.13</b>	12 x 13	212	10	<b>4,90</b>
1655620	<b>0113.15</b>	13 x 15	225	10	<b>5,60</b>
1655639	<b>0113.17</b>	13 x 17	245	10	<b>6,10</b>
1655647	<b>0114.15</b>	14 x 15	225	10	<b>5,10</b>
1655655	<b>0116.17</b>	16 x 17	245	10	<b>6,00</b>
1655663	<b>0117.19</b>	17 x 19	265	10	<b>6,60</b>
1655671	<b>0118.19</b>	18 x 19	265	10	<b>6,40</b>
1655698	<b>0119.22</b>	19 x 22	287	10	<b>8,00</b>
1655701	<b>0120.22</b>	20 x 22	287	10	<b>7,90</b>
1655728	<b>0121.23</b>	21 x 23	305	10	<b>9,40</b>
1655736	<b>0122.24</b>	22 x 24	307	10	<b>9,40</b>
1655752	<b>0124.26</b>	24 x 26	325	10	<b>11,00</b>
1655760	<b>0124.27</b>	24 x 27	325	10	<b>11,00</b>
1655779	<b>0125.28</b>	25 x 28	345	10	<b>11,30</b>
1846493	<b>0127.30</b>	27 x 30	345	10	<b>14,50</b>
1655795	<b>0127.32</b>	27 x 32	370	10	<b>13,70</b>
1655817	<b>0130.32</b>	30 x 32	370	10	<b>13,70</b>
1846507	<b>0132.36</b>	32 x 36	400	10	<b>21,60</b>
1655825	<b>0136.41</b>	36 x 41	440	10	<b>22,60</b>

**Sets**
**Jeux de clés polygales  
Ringsleutelsets**

Code	Ref.	Contenu / Inhoud	€
1693948	<b>0100.08</b>	6x7 8x9 10x11 12x13 14x15 16x17 18x19 20x22	<b>43,00</b>
1693980	<b>0100.100</b>	6x7 8x9 10x11 12x13 14x15 16x17 18x19 20x22 24x27 30x32	<b>68,00</b>
1694006	<b>0100.120</b>	6x7 8x9 10x11 12x13 14x15 16x17 18x19 20x22 21x23 24x27 25x28 30x32	<b>85,00</b>



**Clés mixtes** suivant DIN 3113 forme B, ISO 3318, ISO 7738

- Acier au chrome-Vanadium, chromé

**Ringsteeksleutels** volgens DIN 3113 vorm B ISO 3318, ISO 7738

- Chrom-Vanadium staal, verchroomd

Code	Ref.	Ø mm	l mm	V.E.	€
1655302	<b>0900.06</b>	6	100	10	<b>2,80</b>
1655329	<b>0900.07</b>	7	110	10	<b>2,80</b>
1655337	<b>0900.08</b>	8	120	10	<b>2,80</b>
1655345	<b>0900.09</b>	9	130	10	<b>2,80</b>
1655353	<b>0900.10</b>	10	140	10	<b>3,00</b>
1655361	<b>0900.11</b>	11	150	10	<b>3,20</b>
1655388	<b>0900.12</b>	12	160	10	<b>3,50</b>
1655396	<b>0900.13</b>	13	170	10	<b>3,50</b>
1655418	<b>0900.14</b>	14	180	10	<b>3,80</b>
1655426	<b>0900.15</b>	15	190	10	<b>4,00</b>
1655434	<b>0900.16</b>	16	200	10	<b>4,30</b>
1655442	<b>0900.17</b>	17	210	10	<b>4,30</b>
1655450	<b>0900.18</b>	18	220	10	<b>5,20</b>
1655469	<b>0900.19</b>	19	230	10	<b>5,20</b>
1655477	<b>0900.20</b>	20	240	10	<b>6,20</b>
1655485	<b>0900.21</b>	21	262	10	<b>6,40</b>
1655493	<b>0900.22</b>	22	262	10	<b>6,80</b>
1655507	<b>0900.24</b>	24	282	10	<b>7,80</b>
1655515	<b>0900.27</b>	27	310	10	<b>10,70</b>
1655531	<b>0900.30</b>	30	340	10	<b>11,20</b>
1655558	<b>0900.32</b>	32	370	10	<b>13,40</b>
1655566	<b>0900.34</b>	34	420	10	<b>18,10</b>

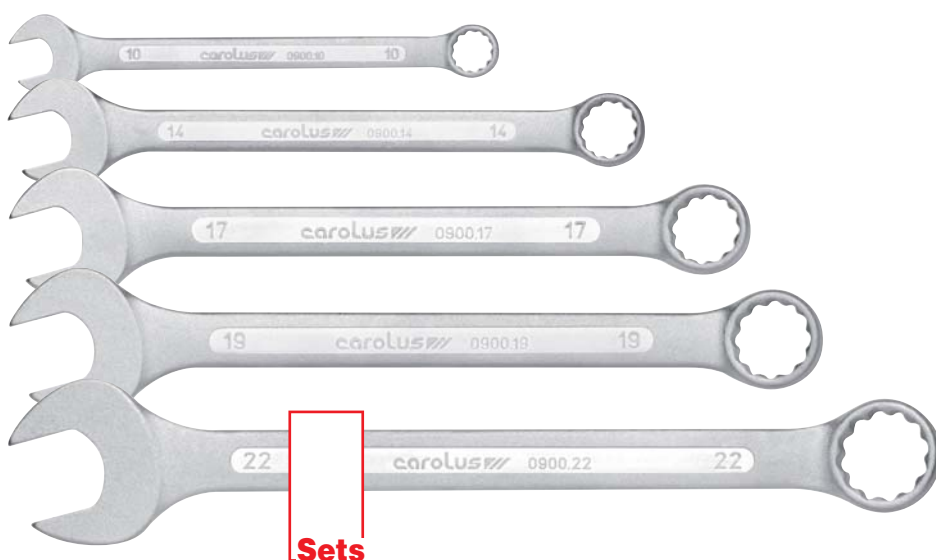

**Jeux de clés mixtes  
Ringsteeksleutelsets**

Code	Ref.	Contenu / Inhoud	€
1694634	<b>0900.080</b>	8 9 10 11 13 14 17 19	<b>30,00</b>
1694669	<b>0900.100</b>	8 10 11 12 13 14 15 17 19 22	<b>39,00</b>
1694707	<b>0900.122</b>	10 11 12 13 14 17 19 22 24 27 30 32	<b>79,00</b>
1813552	<b>0900.210</b>	6 7 8 9 10 11 12 13 14 15 16 17 18 19 20 21 22 24 27 30 32	<b>119,00</b>



### Clés mixtes à cliquet à tête polygonale contre-coudée

- Cliquet réversible
- Acier au chrome-Vanadium, chromé

### Ringratel-steeksleutel met ringzijde gebogen

- Omschakelpal
- Chroom-Vanadium staal, verchromd

Code	Ref.	Ø mm	l mm	V.E.	€
2246953	<b>1710.08</b>	8	134	5	<b>9,70</b>
2246961	<b>1710.09</b>	9	158	5	<b>10,70</b>
2246988	<b>1710.10</b>	10	158	5	<b>11,00</b>
2246996	<b>1710.11</b>	11	164	5	<b>12,20</b>
2247003	<b>1710.12</b>	12	167	5	<b>12,70</b>
2247011	<b>1710.13</b>	13	177	5	<b>13,10</b>
2247038	<b>1710.14</b>	14	189	5	<b>14,10</b>
2247046	<b>1710.15</b>	15	198	5	<b>15,80</b>
2247054	<b>1710.16</b>	16	204	5	<b>16,40</b>
2247062	<b>1710.17</b>	17	224	5	<b>17,30</b>
2247070	<b>1710.18</b>	18	245	5	<b>19,40</b>
2247089	<b>1710.19</b>	19	245	5	<b>20,30</b>
2247097	<b>1710.20</b>	20	280	5	<b>26,80</b>
2247100	<b>1710.21</b>	21	280	5	<b>27,50</b>
2247119	<b>1710.22</b>	22	280	5	<b>27,90</b>
2247127	<b>1710.24</b>	24	310	5	<b>31,30</b>
2247135	<b>1710.27</b>	27	330	5	<b>43,60</b>
2247143	<b>1710.30</b>	30	425	5	<b>57,10</b>
2255766	<b>1710.32</b>	32	425	5	<b>58,20</b>
2247151	<b>1710.34</b>	34	425	1	<b>75,50</b>
2247178	<b>1710.36</b>	36	425	1	<b>90,60</b>



**Sets**

### Jeux de clés mixtes à cliquet en boîte carton

#### Ringratel-steeksleutelset in kartonnen doos

Code	Ref.	Contenu / Inhoud	€
2247186	<b>1710.005</b>	8 10 13 17 19 mm	<b>72,00</b>
2247194	<b>1710.012</b>	8 9 10 11 12 13 14 15 16 17 18 19 mm	<b>173,00</b>

### Jeux de clés mixtes à cliquet en coffret métal

#### Ringratel-steeksleutelset in metalen kistje

Code	Ref.	Contenu / Inhoud	€
1597167	<b>1512.00</b>	8 9 10 11 12 13 14 15 16 17 18 19 mm	<b>235,00</b>

Adaptateurs pour douilles/Adapters voor doppen: 1/4" x 10 mm - 3/8" x 15 mm - 1/2" x 19 mm  
Adaptateurs pour bits/Adapter voor bits: 1/4" x 8 mm - 5/16" x 13 mm

### Clé polygonale à cliquet + jeu d'anneaux mm/Torx

#### Rateeringsleutel + set ringen mm/Torx

Ø 8 9 10 11 12 13 14 15 16 17 19 mm  
E8 E10 E11 E12 E14 E16 E18 E20 E22

Code	Ref.	€
1892266	<b>1520.00</b>	<b>75,00</b>





Clés mixtes à cliquet, forme droite  
Ringratel-steeksleutel, rechte vorm

Code	Ref.	Ø mm	l mm	V.E.	€
2246724	<b>1700.08</b>	8	134.4	1	<b>7,30</b>
2246732	<b>1700.09</b>	9	158.5	1	<b>8,10</b>
2246740	<b>1700.10</b>	10	158.5	1	<b>8,40</b>
2246759	<b>1700.11</b>	11	164.6	1	<b>9,60</b>
2246767	<b>1700.12</b>	12	167.7	1	<b>9,80</b>
2246775	<b>1700.13</b>	13	177.4	1	<b>10,00</b>
2246783	<b>1700.14</b>	14	189.5	1	<b>10,80</b>
2246791	<b>1700.15</b>	15	198.4	1	<b>12,20</b>
2246805	<b>1700.16</b>	16	205.4	1	<b>12,70</b>
2246813	<b>1700.17</b>	17	224.4	1	<b>13,30</b>
2246821	<b>1700.18</b>	18	235.4	1	<b>15,00</b>
2246848	<b>1700.19</b>	19	246.4	1	<b>15,60</b>
2246880	<b>1700.24</b>	24	310.0	1	<b>25,60</b>

Jeu de clés mixtes à cliquet en boîte carton  
Ringratel-steeksleutelset in kartonnen doos

Code	Ref.	Contenu / Inhoud	€
2246937	<b>1700.05</b>	8 10 13 17 19 mm	<b>54,00</b>



Clés mixtes à cliquet, articulées  
Ringratel-steeksleutel, met scharnier

Code	Ref.	Ø mm	l mm	V.E.	€
2247208	<b>1720.08</b>	8	136	1	<b>11,80</b>
2247216	<b>1720.09</b>	9	158	1	<b>12,20</b>
2247224	<b>1720.10</b>	10	158	1	<b>12,30</b>
2247232	<b>1720.11</b>	11	175	1	<b>13,80</b>
2247240	<b>1720.12</b>	12	175	1	<b>13,90</b>
2247259	<b>1720.13</b>	13	185	1	<b>14,10</b>
2247267	<b>1720.14</b>	14	193	1	<b>16,70</b>
2247275	<b>1720.15</b>	15	213	1	<b>17,80</b>
2247283	<b>1720.16</b>	16	213	1	<b>19,00</b>
2247291	<b>1720.17</b>	17	231	1	<b>20,00</b>
2247305	<b>1720.18</b>	18	249	1	<b>21,20</b>
2247313	<b>1720.19</b>	19	249	1	<b>21,60</b>
2247356	<b>1720.22</b>	22	280	1	<b>32,10</b>
2247364	<b>1720.24</b>	24	310	1	<b>36,90</b>

Jeu de clés mixtes à cliquet, articulées  
Ringratel-steeksleutelset, met scharnier

Code	Ref.	Contenu / Inhoud	€
2247372	<b>1720.008</b>	8 9 10 11 13 14 17 19 mm	<b>122,50</b>



### Standard

- Système à levier inverseur - Poignée à 2 composantes
- Omschakelpal - 2-componentengreep

Code	Ref.	↳ mm	€
1515314	<b>4177.20</b>	120	<b>20,40</b>



### Standard

- Système à molette d'inversion - Poignée à 2 composantes
- Schakelschijf - 2-componentengreep

Code	Ref.	↳ mm	€
1519379	<b>7190.30</b>	120	<b>20,40</b>



### Standard-Bit

- Système à levier inverseur - Poignée à 2 composantes
- Omschakelpal - 2-componentengreep

Code	Ref.	↳ mm	€
1515438	<b>4177.26</b>	120	<b>21,10</b>



### Slim SIXTY

- Modèle à tête étroite et mécanisme à 60 dents
- A levier inverseur - Poignée à 2 composantes
- Model met dunne kop en mechanisme met 60 tanden
- Omschakelpal, 2 componenten-greep

Code	Ref.	↳ mm	€
2264951	<b>4190.50</b>	135	<b>26,90</b>



### Readyflex

- Système à levier inverseur
- Tête inclinable, avec arrêts sur 7 positions
- Beweegbare kop met vergrendeling op 7 verschillende posities
- Omschakelpal

Code	Ref.	↳ mm	€
1519654	<b>7225.00</b>	140	<b>36,20</b>



### Readyflex

- Système à molette d'inversion
- Tête inclinable, avec arrêts sur 7 positions
- Beweegbare kop met vergrendeling op 7 verschillende posities
- Schakelschijf

Code	Ref.	↳ mm	€
1519778	<b>7290.30</b>	135	<b>36,20</b>



### Readyflex-Bit

- Système à levier inverseur
- Tête inclinable, avec arrêts sur 7 positions
- Beweegbare kop met vergrendeling op 7 verschillende posities
- Omschakelpal

Code	Ref.	↳ mm	€
1519662	<b>7226.00</b>	140	<b>36,20</b>

**Douille 1/4" 6 pans** ISO 1174  
**Dop 1/4" 6-kant** ISO 1174

Code	Ref.	Ø mm	€
1515187	<b>4177.04</b>	4.0	<b>1,50</b>
1515446	<b>4177.45</b>	4.5	<b>1,50</b>
1515195	<b>4177.05</b>	5.0	<b>1,50</b>
1515454	<b>4177.55</b>	5.5	<b>1,50</b>
1515209	<b>4177.06</b>	6.0	<b>1,50</b>
1515217	<b>4177.07</b>	7.0	<b>1,50</b>
1515225	<b>4177.08</b>	8.0	<b>1,60</b>
1515233	<b>4177.09</b>	9.0	<b>1,60</b>
1515241	<b>4177.10</b>	10.0	<b>1,60</b>
1515276	<b>4177.11</b>	11.0	<b>1,60</b>
1515284	<b>4177.12</b>	12.0	<b>1,60</b>
1515292	<b>4177.13</b>	13.0	<b>1,60</b>
1515306	<b>4177.14</b>	14.0	<b>1,70</b>



**Douille longue 1/4" 6 pans** ISO 1174  
**Dop 1/4" 6-kant met lange huls** ISO 1174

Code	Ref.	Ø mm	€
1515039	<b>4176.04</b>	4.0	<b>2,20</b>
1515160	<b>4176.45</b>	4.5	<b>2,40</b>
1515055	<b>4176.05</b>	5.0	<b>2,40</b>
1515179	<b>4176.55</b>	5.5	<b>2,40</b>
1515063	<b>4176.06</b>	6.0	<b>2,40</b>
1515071	<b>4176.07</b>	7.0	<b>2,40</b>
1515098	<b>4176.08</b>	8.0	<b>2,40</b>
1515101	<b>4176.09</b>	9.0	<b>2,40</b>
1515128	<b>4176.10</b>	10.0	<b>2,40</b>
1515136	<b>4176.11</b>	11.0	<b>2,60</b>
1515144	<b>4176.12</b>	12.0	<b>2,60</b>
1515152	<b>4176.13</b>	13.0	<b>2,60</b>



**Douille TORX 1/4"** ISO 1174  
**Dop TORX 1/4"** ISO 1174

Code	Ref.	⊕	€
1514784	<b>4174.05</b>	E 5	<b>3,40</b>
1514792	<b>4174.06</b>	E 6	<b>3,40</b>
1514806	<b>4174.07</b>	E 7	<b>3,40</b>
1514814	<b>4174.08</b>	E 8	<b>3,40</b>
1514822	<b>4174.10</b>	E10	<b>3,60</b>



**Douille-tournevis 1/4"** ISO 1174  
**Dopschroevendraaier 1/4"** ISO 1174

Code	Ref.	⊕	€
2252260	<b>4173.08</b>	TXB 8	<b>2,10</b>
2252279	<b>4173.09</b>	TXB 9	<b>2,10</b>
1514709	<b>4173.10</b>	TXB10	<b>2,10</b>
1514717	<b>4173.15</b>	TXB15	<b>2,10</b>
1514725	<b>4173.20</b>	TXB20	<b>2,10</b>
1514733	<b>4173.25</b>	TXB25	<b>2,10</b>
1514741	<b>4173.27</b>	TXB27	<b>2,10</b>
1514768	<b>4173.30</b>	TXB30	<b>2,10</b>
1514776	<b>4173.40</b>	TXB40	<b>2,10</b>



**Douille-tournevis 1/4"** ISO 1174  
**Dopschroevendraaier 1/4"** ISO 1174

Code	Ref.	mm ±	€
1515632	<b>4179.04</b>	4.0	<b>1,90</b>
1515667	<b>4179.55</b>	5.5	<b>1,90</b>
1515713	<b>4179.65</b>	6.5	<b>1,90</b>



**Douille-tournevis 1/4"** ISO 1174  
**Dopschroevendraaier 1/4"** ISO 1174

Code	Ref.	mm	€
1515470	<b>4178.03</b>	3	<b>1,60</b>
1515489	<b>4178.04</b>	4	<b>1,60</b>
1515497	<b>4178.05</b>	5	<b>1,60</b>
1515500	<b>4178.06</b>	6	<b>1,60</b>
1515519	<b>4178.08</b>	8	<b>1,60</b>
1515535	<b>4178.10</b>	10	<b>1,60</b>



**Douille-tournevis 1/4"** ISO 1174  
**Dopschroevendraaier 1/4"** ISO 1174

Code	Ref.	⊕	€
1515756	<b>4179.10</b>	Ph0	<b>1,90</b>
1515764	<b>4179.20</b>	Ph1	<b>1,90</b>
1515772	<b>4179.30</b>	Ph2	<b>1,90</b>
1515780	<b>4179.40</b>	Ph3	<b>1,90</b>



**Douille-tournevis 1/4"** ISO 1174  
**Dopschroevendraaier 1/4"** ISO 1174

Code	Ref.	⊕	€
1514660	<b>4172.00</b>	Pz0	<b>2,10</b>
1514679	<b>4172.10</b>	Pz1	<b>2,10</b>
1514687	<b>4172.20</b>	Pz2	<b>2,10</b>
1514695	<b>4172.30</b>	Pz3	<b>2,10</b>





### Allonge / Verlengstuk

Code	Ref.	↳ mm	€
1515616	<b>4179.50</b>	50	<b>2,10</b>
1515608	<b>4179.00</b>	100	<b>2,50</b>
1515624	<b>4179.15</b>	150	<b>4,00</b>



### Poignée coulissante / Schuifgreep

Code	Ref.	↳ mm	€
1515799	<b>4179.70</b>	115	<b>5,00</b>



### Cardan / Cardangewricht

Code	Ref.	↳ mm	€
1515802	<b>4179.80</b>	38	<b>5,80</b>



### Adaptateur pour bit avec aimant Bit-adapter met magneet

Code	Ref.	↳ mm	€
15192220	<b>7060.00</b>	1/4" 8	<b>3,50</b>



### Adaptateur pour bit / Bit-adapter

Code	Ref.	↳ mm	€
1597132	<b>4115.10</b>	1/4" 10	<b>3,60</b>



### Adaptateur 1/4" / Adapter 1/4"

Code	Ref.	↳ mm	€
1515551	<b>4178.60</b>	1/4" 1/4"	<b>1,90</b>



### Embout aimanté / Magneetzoeker

Code	Ref.	↳ mm	€
1515543	<b>4178.50</b>	1/4"	<b>3,30</b>



### Adaptateur 1/4" / Adapter 1/4"

Code	Ref.	↳ mm	€
1519255	<b>7080.00</b>	1/4" 1/4"	<b>0,90</b>



### Adaptateur 1/4" / Adapter 1/4"

Code	Ref.	↳ mm	€
1519263	<b>7080.50</b>	1/4" 1/4"	<b>1,30</b>



### Poignée 1/4" / Handgreep 1/4"

Code	Ref.	↳ mm	€
2252430	<b>4120.00</b>	1/4" 180	<b>4,90</b>



**Composition de douilles SLIM SIXTY** **16 pièces**  
**Doppenset SLIM SIXTY** **16-delig**

Cliquet à levier inverseur / Ratel met schakel-pal  
 Allonges / Verlengstukken: 50 mm - 150 mm  
 Douilles / Doppen  $\square$  4 4.5 5 5.5 6 7 8 9 10 11 12 13 14 mm

Code	Ref.	€
2253585	<b>4400.100</b>	<b>45,00</b>



**Composition de douilles SLIM SIXTY** **35 pièces**  
**Doppenset SLIM SIXTY** **35-delig**

Cliquet à levier inverseur / Ratel met schakel-pal  
 Allonges / Verlengstukken: 50 mm - 150 mm  
 Cardan / Cardangewricht  
 Poignée T en réducteur 3/8"-1/4" / T-greep en adapter 3/8"-1/4"  
 Poignée porte-bit / Bit schroevendraaier  
 Adaptateur / Adapter 1/4"-1/4"  
 Adaptateur / Adapter 1/4"-1/4" bit  
 Douilles / Doppen  $\square$  4 4.5 5 5.5 6 7 8 9 10 11 12 13 14 mm  
 Bits  $\oplus$  T8 T10 T15 T20 T25 T27 T30 T40  
 Bits  $\bullet$  3 4 5 6 8 10 mm

Code	Ref.	€
2253615	<b>4430.100</b>	<b>73,00</b>



**Composition de douilles SLIM SIXTY** **41 pièces**  
**Doppenset SLIM SIXTY** **41-delig**

Cliquet à levier inverseur / Ratel met schakel-pal  
 Allonge / Verlengstuk: 100 mm  
 Cardan / Cardangewricht  
 Poignée porte-bit / Bit schroevendraaier  
 Adaptateur / Adapter 1/4"-1/4"  
 Adaptateur / Adapter 1/4"-1/4" bit  
 Douilles / Doppen  $\square$  4 4.5 5 5.5 6 7 8 9 10 11 12 13 14 mm  
 Bits  $\ominus$  4.5 5.5 6.5 mm  
 Bits  $\oplus$  Ph1 Ph2  
 Bits  $\oplus$  Pz1 Pz2 Pz3  
 Bits  $\oplus$  T10 T15 T20 T25 T27 T30 T40  
 Bits  $\bullet$  3 4 5 6 mm  
 Bits  $\bullet$  5 6 8 mm

Code	Ref.	€
2253607	<b>4430.205</b>	<b>62,00</b>

**Composition de douilles  
Doppenset**
**33 pièces  
33-delig**

Cliquet à levier inverseur / Ratel met schakel-pal  
 Allonges / Verlengstukken: 50 mm - 100 mm  
 Cardan / Cardangewricht  
 Poignée coulissante / Schuifgreep  
 Poignée MINIMUS 1/4" / Handgreep MINIMUS 1/4"  
 Adaptateur machine ■ 1/4" x ● 1/4" Machine adapter  
 Douilles / Doppen □ 4 4.5 5 5.5 6 7 8 9 10 11 12 13 mm  
 Douilles-tournevis / Schroevendraaierdoppen  
 ● 3 4 5 6 8 10 mm  
 ⊖ 4 5.5 6.5 mm  
 ⊕ Ph0 Ph1 Ph2 Ph3

Code	Ref.	€
1514288	<b>4004.77</b>	<b>76,00</b>

**Composition de douilles  
Doppenset**
**33 pièces  
33-delig**

Cliquet à levier inverseur / Ratel met schakel-pal  
 Allonges / Verlengstukken: 50 mm - 100 mm  
 Cardan / Cardangewricht  
 Poignée coulissante / Schuifgreep  
 Poignée MINIMUS 1/4" / Handgreep MINIMUS 1/4"  
 Adaptateur machine ■ 1/4" x ● 1/4" Machine adapter  
 Douilles / Doppen □ 4 4.5 5 5.5 6 7 8 9 10 11 12 13 mm  
 Douilles-tournevis / Schroevendraaierdoppen  
 ● 3 4 5 6 8 10 mm  
 ⊕ T10 T15 T20 T25 T27 T30 T40

Code	Ref.	€
1514326	<b>4004.79</b>	<b>76,00</b>

**Composition de douilles  
Doppenset**
**33 pièces  
33-delig**

Cliquet à molette d'inversion / Ratel met schakelschijf  
 Allonges / Verlengstukken: 50 mm - 100 mm  
 Cardan / Cardangewricht  
 Poignée coulissante / Schuifgreep  
 Poignée MINIMUS 1/4" / Handgreep MINIMUS 1/4"  
 Adaptateur machine ■ 1/4" x ● 1/4" Machine adapter  
 Douilles / Doppen □ 4 4.5 5 5.5 6 7 8 9 10 11 12 13 mm  
 Douilles-tournevis / Schroevendraaierdoppen  
 ● 3 4 5 6 8 10 mm  
 ⊕ T10 T15 T20 T25 T27 T30 T40

Code	Ref.	€
1514512	<b>4004.99</b>	<b>76,00</b>



**Composition de douilles  
Doppenset**

**33 pièces  
33-delig**

Cliquet READYFLEX / Ratel READYFLEX  
 Allonges / Verlengstukken: 50 mm - 100 mm  
 Cardan / Cardangewricht  
 Poignée coulissante / Schuifgreep  
 Poignée MINIMUS 1/4" / Handgreep MINIMUS 1/4"  
 Adaptateur machine ■ 1/4" x ● 1/4" Machine adapter  
 Adaptateur pour bit 1/4" / Adapter voor bit 1/4"  
 Douilles / Doppen □ 4 4.5 5 5.5 6 7 8 9 10 11 12 13 mm  
 Douilles-tournevis / Schroevendraaierdoppen  
 ● 3 4 5 6 8 10 mm  
 ⊖ 4 5.5 6.5 mm  
 ⊕ Ph0 Ph1 Ph2 Ph3

Code	Ref.	€
1514431	<b>4004.90</b>	<b>91,00</b>



**Composition de douilles  
Doppenset**

**33 pièces  
33-delig**

Cliquet READYFLEX / Ratel READYFLEX  
 Allonges / Verlengstukken: 50 mm - 100 mm  
 Cardan / Cardangewricht  
 Poignée coulissante / Schuifgreep  
 Poignée MINIMUS 1/4" / Handgreep MINIMUS 1/4"  
 Adaptateur machine ■ 1/4" x ● 1/4" Machine adapter  
 Adaptateur pour bit 1/4" / Adapter voor bit 1/4"  
 Douilles / Doppen □ 4 4.5 5 5.5 6 7 8 9 10 11 12 13 mm  
 Douilles-tournevis / Schroevendraaierdoppen  
 ● 3 4 5 6 8 10 mm  
 ⊕ T10 T15 T20 T25 T27 T30 T40

Code	Ref.	€
1514458	<b>4004.91</b>	<b>91,00</b>



**Composition de douilles  
Doppenset**

**37 pièces  
37-delig**

Cliquet READYFLEX / Ratel READYFLEX  
 Allonges / Verlengstukken: 50 mm - 100 mm  
 Cardan / Cardangewricht  
 Poignée coulissante / Schuifgreep  
 Embout aimanté / Magneetzoeker  
 Poignée MINIMUS 1/4" / Handgreep MINIMUS 1/4"  
 Adaptateur machine ■ 1/4" x ● 1/4" Machine adapter  
 Adaptateur pour bit 1/4" / Adapter voor bit 1/4"  
 Douilles / Doppen □ 4 4.5 5 5.5 6 7 8 9 10 11 12 13 mm  
 Douilles-tournevis / Schroevendraaierdoppen  
 ● 4 5 6 mm  
 ⊖ 5.5  
 ⊕ Ph2  
 ⊕ Pz2  
 ⊕ T10 T15 T20 T25 T27 T30 T40

Code	Ref.	€
1514377	<b>4004.84</b>	<b>99,00</b>



### Standard

- Système à levier inverseur - Poignée à 2 composantes
- Omschakelpal - 2-componentengreep

Code	Ref.	↳ mm ↲	€
1518038	<b>6190.20</b>	210	<b>21,40</b>



### Standard

- Système à molette d'inversion - Poignée à 2 composantes
- Schakelschijf - 2-componentengreep

Code	Ref.	↳ mm ↲	€
1518046	<b>6190.30</b>	210	<b>21,40</b>



### Slim SIXTY

- Modèle à tête étroite et mécanisme à 60 dents
- Model met dunne kop en mechanisme met 60 tanden

Code	Ref.	↳ mm ↲	€
2264994	<b>6190.50</b>	195	<b>29,70</b>



### Readyflex

- Système à levier inverseur
- Tête inclinable, avec arrêts sur 7 positions
- Beweegbare kop met vergrendeling op 7 verschillende posities
- Schakelpal

Code	Ref.	↳ mm ↲	€
1696556	<b>6225.00</b>	225	<b>38,60</b>

### Douille 3/8" 6 pans Dop 3/8" 6-kant

ISO 1174  
ISO 1174

Code	Ref.	Ø mm	€
2252465	<b>6100.07</b>	7	<b>2,60</b>
1517708	<b>6100.08</b>	8	<b>2,60</b>
2252473	<b>6100.09</b>	9	<b>2,60</b>
1517716	<b>6100.10</b>	10	<b>2,60</b>
1517724	<b>6100.11</b>	11	<b>2,60</b>
1517732	<b>6100.12</b>	12	<b>2,60</b>
1517740	<b>6100.13</b>	13	<b>2,60</b>
1517759	<b>6100.14</b>	14	<b>2,60</b>
1517767	<b>6100.15</b>	15	<b>2,80</b>
1517775	<b>6100.16</b>	16	<b>2,80</b>
1517783	<b>6100.17</b>	17	<b>2,80</b>
1517791	<b>6100.18</b>	18	<b>2,80</b>
1517805	<b>6100.19</b>	19	<b>2,80</b>
2252481	<b>6100.20</b>	20	<b>3,30</b>
2252503	<b>6100.21</b>	21	<b>3,30</b>
1517813	<b>6100.22</b>	22	<b>3,30</b>
1517821	<b>6100.24</b>	24	<b>3,30</b>



### Douille TORX 3/8" Dop TORX 3/8"

ISO 1174  
ISO 1174

Code	Ref.	Ø	€
1518224	<b>6300.10</b>	E10	<b>2,60</b>
2252511	<b>6300.11</b>	E11	<b>2,60</b>
1518232	<b>6300.12</b>	E12	<b>2,60</b>
1518240	<b>6300.14</b>	E14	<b>2,80</b>
1518259	<b>6300.16</b>	E16	<b>2,80</b>
2252538	<b>6300.18</b>	E18	<b>2,90</b>



### Allonge / Verlengstuk

Code	Ref.	↳ mm ↲	€
1517902	<b>6150.45</b>	45	<b>3,60</b>
2252589	<b>6150.125</b>	125	<b>3,50</b>
1517899	<b>6150.15</b>	150	<b>4,50</b>
2252597	<b>6150.250</b>	250	<b>6,80</b>

### Douilles pour bougies avec aimant Bougiedopsleutel met magneet

Code	Ref.	Ø mm	€
2252562	<b>6080.14</b>	14.0	<b>8,80</b>
1517449	<b>6080.16</b>	16.0	<b>8,80</b>
2252570	<b>6080.18</b>	18.0	<b>8,80</b>
1517457	<b>6080.21</b>	20.8	<b>8,80</b>



### Cardan / Cardangewricht

Code	Ref.	↳ mm ↲	€
1517880	<b>6130.00</b>	51	<b>6,20</b>



### Allonge avec déclencheur Verlengstuk met ontgrendeling

Code	Ref.	↳ mm ↲	€
1850458	<b>6151.15</b>	150	<b>8,50</b>
1850466	<b>6151.25</b>	250	<b>10,10</b>
1850474	<b>6151.30</b>	300	<b>13,50</b>







**Composition de douilles SLIM SIXTY  
Doppenset SLIM SIXTY**

**12 pièces  
12-delig**

Cliquet à levier inverseur / Ratel met schakelpal  
Douilles / Doppen  $\square$  6 7 8 9 10 11 13 14 17 19 mm  
Poignée coulissante/allonge avec réducteur 3/8" - 1/4"  
Schuifgreep/verlengstuk met adapter 3/8" - 1/4"

Code	Ref.	€
2253658	<b>6600.100</b>	<b>48,00</b>



**Composition de douilles SLIM SIXTY  
Doppenset SLIM SIXTY**

**22 pièces  
22-delig**

Cliquet à levier inverseur / Ratel met schakelpal  
Douilles / Doppen  $\square$  6 7 8 9 10 11 13 14 15 17 19 20 21 22 mm  
Allonges / Verlengstukken: 125 mm - 250 mm  
Cardan / Cardangewricht  
Poignée coulissante/allonge avec réducteur 3/8" - 1/4"  
Schuifgreep/verlengstuk met adapter 3/8" - 1/4"

Code	Ref.	€
2253666	<b>6600.300</b>	<b>85,00</b>



**Composition de douilles SLIM SIXTY  
Doppenset SLIM SIXTY**

**40 pièces  
40-delig**

Cliquet à levier inverseur / Ratel met schakelpal  
Douilles / Doppen  
 $\square$  6 7 8 9 10 11 12 13 14 15 16 17 18 19 20 21 22 24 mm  
 $\otimes$  E10 E11 E12 E14 E16 E18 E20  
Douilles-tournevis / Dopschroevendraaiers  
 $\otimes$  T10 T15 T20 T25 T27 T30 T40  
Allonges / Verlengstukken: 125 mm - 250 mm  
Cardan / Cardangewricht  
Poignée coulissante/allonge avec réducteur 3/8" - 1/4"  
Schuifgreep/verlengstuk met adapter 3/8" - 1/4"  
Douilles à bougie / Bougiedoppen 14 16 18 mm

Code	Ref.	€
2253682	<b>6600.500</b>	<b>137,00</b>



### Readyflex

- Système à levier inverseur
- Tête inclinable, avec arrêts sur 7 positions
- *Beweegbare kop met vergrendeling op 7 verschillende posities*
- *Schakelpal*

Code	Ref.	↳ mm	€
1696041	<b>5225.00</b>	270	<b>43,00</b>



### Readyflex

- Système à molette d'inversion
- Tête inclinable, avec arrêts sur 7 positions
- *Beweegbare kop met vergrendeling op 7 verschillende posities*
- *Schakelschijf*

Code	Ref.	↳ mm	€
1696068	<b>5290.00</b>	260	<b>43,00</b>



### Slim SIXTY

- Modèle à tête étroite et mécanisme à 60 dents
- Système à levier inverseur . Poignée à 2 composantes
- *Model met dunne kop en mechanisme met 60 tanden*
- *Omschakelpal - 2-componentengreep*

Code	Ref.	↳ mm	€
2265001	<b>5190.50</b>	250	<b>32,50</b>



### Standard

- Système à levier inverseur - Poignée à 2 composantes
- *Omschakelpal - 2-componentengreep*

Code	Ref.	↳ mm	€
1516698	<b>5190.20</b>	280	<b>27,50</b>



### Standard

- Système à molette d'inversion - Poignée à 2 composantes
- *Schakelschijf - 2-componentengreep*

Code	Ref.	↳ mm	€
1516701	<b>5190.30</b>	280	<b>27,50</b>



### Standard

- Avec carré conducteur interchangeable - Poignée à 2 composantes
- *Met doorsteek vierkant - 2-componentengreep*

Code	Ref.	↳ mm	€
1920995	<b>5170.00</b>	270	<b>21,50</b>

**Douille 1/2" 6 pans**  
**Dop 1/4" 6-kant**

ISO 1174

ISO 1174

Code	Ref.	Ø mm	€
2252759	<b>5100.08</b>	8	<b>2,90</b>
2252767	<b>5100.09</b>	9	<b>2,90</b>
1516329	<b>5100.10</b>	10	<b>2,90</b>
1516345	<b>5100.11</b>	11	<b>2,90</b>
1516353	<b>5100.12</b>	12	<b>2,90</b>
1516388	<b>5100.13</b>	13	<b>3,00</b>
1516418	<b>5100.14</b>	14	<b>3,00</b>
1516426	<b>5100.15</b>	15	<b>3,00</b>
1516434	<b>5100.16</b>	16	<b>3,00</b>
1516442	<b>5100.17</b>	17	<b>3,30</b>
1516450	<b>5100.18</b>	18	<b>3,30</b>
1516469	<b>5100.19</b>	19	<b>3,30</b>
1516477	<b>5100.20</b>	20	<b>3,70</b>
1516485	<b>5100.21</b>	21	<b>3,70</b>
1516493	<b>5100.22</b>	22	<b>3,70</b>
1516507	<b>5100.23</b>	23	<b>4,00</b>
1516515	<b>5100.24</b>	24	<b>4,00</b>
1516523	<b>5100.26</b>	26	<b>4,30</b>
1516531	<b>5100.27</b>	27	<b>4,30</b>
1516558	<b>5100.28</b>	28	<b>5,40</b>
1516566	<b>5100.30</b>	30	<b>5,40</b>
1516574	<b>5100.32</b>	32	<b>5,40</b>
2252775	<b>5100.34</b>	34	<b>6,00</b>

**Douille longue 1/2" 6 pans**  
**Dop 1/2" 6-kant met lange huls**

ISO 1174

ISO 1174

Code	Ref.	Ø mm	€
1848690	<b>5106.10</b>	10	<b>5,70</b>
2253097	<b>5106.11</b>	11	<b>5,70</b>
1848704	<b>5106.12</b>	12	<b>5,70</b>
1848712	<b>5106.13</b>	13	<b>5,70</b>
1848720	<b>5106.14</b>	14	<b>6,30</b>
1848739	<b>5106.15</b>	15	<b>6,30</b>
2253100	<b>5106.16</b>	16	<b>6,30</b>
1848747	<b>5106.17</b>	17	<b>6,30</b>
2253119	<b>5106.18</b>	18	<b>6,30</b>
1848755	<b>5106.19</b>	19	<b>6,60</b>
1848763	<b>5106.21</b>	21	<b>6,60</b>
1848771	<b>5106.22</b>	22	<b>6,60</b>
1848798	<b>5106.23</b>	23	<b>6,60</b>
1848801	<b>5106.24</b>	24	<b>7,10</b>
1848828	<b>5106.27</b>	27	<b>8,50</b>
1848836	<b>5106.30</b>	30	<b>9,00</b>
1848844	<b>5106.32</b>	32	<b>10,00</b>
2253127	<b>5106.34</b>	34	<b>11,10</b>

**Douille TORX 1/2"**  
**Dop TORX 1/2"**

ISO 1174

ISO 1174

Code	Ref.	⊕	€
1849077	<b>5300.10</b>	E10	<b>5,00</b>
1849085	<b>5300.11</b>	E11	<b>5,00</b>
1849093	<b>5300.12</b>	E12	<b>5,00</b>
1849107	<b>5300.14</b>	E14	<b>5,00</b>
1849115	<b>5300.16</b>	E16	<b>5,20</b>
1849123	<b>5300.18</b>	E18	<b>5,20</b>
1849131	<b>5300.20</b>	E20	<b>5,60</b>
1849158	<b>5300.22</b>	E22	<b>5,90</b>
1849166	<b>5300.24</b>	E24	<b>6,50</b>

**Douille-tournevis 1/2"**  
**Dopschroevendraaier 1/2"**

ISO 1174

ISO 1174

Code	Ref.	⊕	€
2253224	<b>5303.20</b>	T20	<b>5,30</b>
2253232	<b>5303.25</b>	T25	<b>5,30</b>
2253240	<b>5303.27</b>	T27	<b>5,70</b>
1849174	<b>5303.30</b>	T30	<b>5,70</b>
1849182	<b>5303.40</b>	T40	<b>5,70</b>
1849190	<b>5303.45</b>	T45	<b>6,00</b>
1849204	<b>5303.50</b>	T50	<b>6,00</b>
1849212	<b>5303.55</b>	T55	<b>7,80</b>
1849220	<b>5303.60</b>	T60	<b>8,10</b>
1849239	<b>5303.70</b>	T70	<b>8,10</b>

**Douille-tournevis INBUS 1/2"**  
**Dopschroevendraaier INBUS 1/2"**

ISO 1174

ISO 1174

Code	Ref.	⊕ mm /   - mm ▶	€
2253186	<b>5135.04</b>	4 60	<b>5,20</b>
1829319	<b>5135.05</b>	5 60	<b>5,20</b>
1829327	<b>5135.06</b>	6 60	<b>5,20</b>
1829335	<b>5135.07</b>	7 60	<b>5,20</b>
1829343	<b>5135.08</b>	8 60	<b>5,20</b>
1829394	<b>5135.09</b>	9 60	<b>5,50</b>
1829351	<b>5135.10</b>	10 60	<b>5,50</b>
1829408	<b>5135.11</b>	11 60	<b>5,50</b>
1829378	<b>5135.12</b>	12 60	<b>5,50</b>
1829416	<b>5135.14</b>	14 60	<b>5,70</b>
1829424	<b>5135.17</b>	17 60	<b>6,10</b>
2253194	<b>5135.19</b>	19 60	<b>6,30</b>

**Douille-tournevis INBUS 1/2"**  
**Dopschroevendraaier INBUS 1/2"**

ISO 1174

ISO 1174

Code	Ref.	⊕ mm /   - mm ▶	€
1848887	<b>5136.05</b>	5 80	<b>5,50</b>
1849034	<b>5142.05</b>	5 180	<b>7,90</b>
1848909	<b>5136.06</b>	6 80	<b>5,50</b>
1848984	<b>5141.06</b>	6 140	<b>7,00</b>
1848976	<b>5138.07</b>	7 100	<b>5,50</b>
1848917	<b>5136.08</b>	8 80	<b>5,50</b>
1849689	<b>5139.08</b>	8 120	<b>6,50</b>
1848992	<b>5141.10</b>	10 140	<b>7,90</b>
1849018	<b>5141.12</b>	12 140	<b>8,10</b>
1849026	<b>5141.14</b>	14 140	<b>8,10</b>



**Douilles pour bougies avec aimant  
Bougiedopsleutel met magneet**

Code	Ref.	mm	€
1696025	<b>5180.16</b>	16.0	<b>7,10</b>
1696033	<b>5180.21</b>	20.8	<b>7,80</b>

**Cardan / Cardangewricht**

Code	Ref.	mm	€
1516604	<b>5130.00</b>	73	<b>7,70</b>

**Adaptateur / Adapter 1/2" x 5/16"**

Code	Ref.	x	€
1516655	<b>5160.00</b>	1/2" x 5/16"	<b>3,10</b>

**Adaptateur / Adapter 1/2" x 5/16"**

Code	Ref.	x	€
1517422	<b>6070.50</b>	1/2" x 5/16"	<b>3,10</b>

**Allonge / Verlengstuk**

Code	Ref.	mm	€
1516647	<b>5150.75</b>	75	<b>4,20</b>
1516620	<b>5150.12</b>	125	<b>4,70</b>
1516639	<b>5150.25</b>	250	<b>6,80</b>

**Allonge avec déclencheur  
Verlengstuk met ontgrendeling**

Code	Ref.	mm	€
1849042	<b>5151.12</b>	125	<b>14,60</b>
1849050	<b>5151.25</b>	250	<b>15,70</b>
1849069	<b>5151.37</b>	375	<b>21,40</b>

**Poignée coulissante / Schuifgreep**

Code	Ref.	mm	€
1516612	<b>5140.00</b>	270	<b>7,90</b>

**Douilles à choc 6 pans  
Impact dop 6-kant**

Code	Ref.	mm	€
1849387	<b>5400.10</b>	10	<b>4,10</b>
1849395	<b>5400.11</b>	11	<b>4,10</b>
1849409	<b>5400.12</b>	12	<b>4,10</b>
1849417	<b>5400.13</b>	13	<b>4,10</b>
1849425	<b>5400.14</b>	14	<b>4,10</b>
1849433	<b>5400.15</b>	15	<b>4,10</b>
1849441	<b>5400.16</b>	16	<b>4,30</b>
1849468	<b>5400.17</b>	17	<b>4,30</b>
1849476	<b>5400.19</b>	19	<b>4,30</b>
1849484	<b>5400.21</b>	21	<b>4,60</b>
1849492	<b>5400.22</b>	22	<b>4,60</b>
1849506	<b>5400.24</b>	24	<b>5,40</b>
1849514	<b>5400.27</b>	27	<b>6,80</b>
1849522	<b>5400.30</b>	30	<b>7,90</b>
1849530	<b>5400.32</b>	32	<b>7,90</b>

**Douilles à choc 6 pans - L 85 mm  
Impact dop 6-kant - L 85 mm**

Code	Ref.	mm	€
1849549	<b>5406.10</b>	10	<b>6,70</b>
1849557	<b>5406.11</b>	11	<b>6,70</b>
1849565	<b>5406.12</b>	12	<b>6,70</b>
1849573	<b>5406.13</b>	13	<b>6,70</b>
1849581	<b>5406.14</b>	14	<b>6,70</b>
1849603	<b>5406.15</b>	15	<b>7,40</b>
1849611	<b>5406.16</b>	16	<b>7,40</b>
1849638	<b>5406.17</b>	17	<b>7,40</b>
1849646	<b>5406.19</b>	19	<b>7,60</b>
1849654	<b>5406.21</b>	21	<b>8,10</b>
1849662	<b>5406.22</b>	22	<b>8,40</b>
1849670	<b>5406.24</b>	24	<b>8,80</b>

**Douilles à choc pour vis à 6 pans creux  
Impact dop voor INBUS schroeven**

Code	Ref.	mm	€
2682451	<b>5435.10</b>	10	<b>10,40</b>
2682478	<b>5435.12</b>	12	<b>10,40</b>
2682486	<b>5435.14</b>	14	<b>10,40</b>
2682494	<b>5435.17</b>	17	<b>12,20</b>
2682508	<b>5435.19</b>	19	<b>14,00</b>

**Douilles à choc pour boulons de roues  
Impact dop voor wielenbouten**

Code	Ref.	mm	€
1889893	<b>5575.17</b>	17	<b>10,10</b>
1889907	<b>5575.19</b>	19	<b>10,10</b>
1889915	<b>5575.21</b>	21	<b>10,10</b>



**Composition de douilles SLIM SIXTY 12 pièces**  
**Doppenset SLIM SIXTY 12-delig**

Cliquet à levier inverseur / Ratel met schakelpal  
 Douilles / Doppen  $\square$  10 11 13 14 15 17 19 22 24 27 mm  
 Allonge à poignée T avec réducteur 3/8" - 1/2"  
 T-greep verlengstuk met adapter 3/8" - 1/2"

Code	Ref.	€
2253704	<b>5500.100</b>	<b>69,00</b>



**Composition de douilles SLIM SIXTY 32 pièces**  
**Doppenset SLIM SIXTY 32-delig**

Cliquet à levier inverseur / Ratel met schakelpal  
 Douilles / Doppen  
 $\square$  8 10 11 12 13 14 15 16 17 18 19 20 21 22 24 27 30 32 34 mm  
 Douilles-tournevis / Dopschroevendraaiers  
 $\bullet$  5 6 7 8 10 12 14 17 mm  
 Allonges / Verlengstukken: 125 mm - 250 mm  
 Cardan / Cardangewricht  
 Allonge à poignée T avec réducteur 3/8" - 1/2"  
 T-greep verlengstuk met adapter 3/8" - 1/2"

Code	Ref.	€
2253720	<b>5500.400</b>	<b>140,00</b>



**Composition de douilles SLIM SIXTY 33 pièces**  
**Doppenset SLIM SIXTY 33-delig**

Cliquet à levier inverseur / Ratel met schakelpal  
 Douilles / Doppen  
 $\square$  8 10 11 12 13 14 15 16 17 18 19 20 21 22 24 27 30 32 34 mm  
 Douilles-tournevis / Dopschroevendraaiers  
 $\bullet$  T20 T25 T27 T30 T40 T45 T50 T55 T60  
 Allonges / Verlengstukken: 125 mm - 250 mm  
 Allonge à poignée T avec réducteur 3/8" - 1/2"  
 T-greep verlengstuk met adapter 3/8" - 1/2"

Code	Ref.	€
2253739	<b>5500.525</b>	<b>137,00</b>



**Composition de douilles 1/2"-1/4" SLIM SIXTY 34 pièces**  
**Doppenset SLIM SIXTY 34-delig**

Cliquet 1/2" à levier inverseur / Ratel 1/2" met schakelpal  
 Douilles / Doppen  $\square$  14 15 16 17 18 19 20 21 22 24 27 30 32 34 mm 1/2"  
 Clés à bougie / Bougiedopsleutels: 16.0 mm - 20.8 mm  
 Allonges / Verlengstukken: 250 mm  
 Cardan / Cardangewricht

Cliquet 1/4" à levier inverseur / Ratel 1/4" met schakelpal 1/4"  
 Douilles / Doppen  $\square$  4 4.5 5 5.5 6 7 8 9 10 11 12 13 mm  
 Allonge / Verlengstuk  
 Cardan / Cardangewricht

Code	Ref.	€
2253755	<b>5544.400</b>	<b>139,00</b>

**Composition de douilles  
Doppenset** **24 pièces  
24-delig**

Cliquet à levier inverseur / Ratel met schakelpal  
 ⬡ 10 11 12 13 14 15 16 17 18 19 21 22 24 27 30 32 mm  
 Allonges / Verlengstukken: 75 mm - 125 mm - 250 mm  
 Cardan / Cardangewricht  
 Poignée coulissante / Schuifgreep  
 Adaptateur pour bit / Adapter voor bit: 1/2" x 5/16"

Code	Ref.	€
1516191	<b>5000.00</b>	<b>120,00</b>

**Composition de douilles 1/2"-1/4"  
Doppenset 1/2"-1/4"** **49 pièces  
49-delig**

Cliquet 1/2" à levier inverseur / Ratel 1/2" met schakelpal  
 Douilles / Doppen ⬡ 10 11 12 13 14 15 16 17 18 19 21 22 24 mm  
 Allonges / Verlengstukken: 75 mm - 125 mm - 250 mm 1/2"  
 Cardan / Cardangewricht  
 Poignée coulissante / Schuifgreep  
 Adaptateur pour bit / Adapter voor bit: 1/2" x 5/16"

Cliquet 1/4" à levier inverseur / Ratel 1/4" met schakelpal 1/4"  
 Douilles / Doppen ⬡ 4 4.5 5 5.5 6 7 8 10 11 12 13 mm  
 Douilles-tournevis 1/4" / Dopschroevendraaiers 1/4"  
 ⬢ T10 T15 T20 T25 T27 T30 T40

● 4 5 6 8 mm  
 ⊖ 5.5 mm  
 ⊕ Ph2  
 ⊕ Pz 2  
 Allonges / Verlengstukken: 50 mm - 100 mm  
 Cardan / Cardangewricht

Code	Ref.	€
1516906	<b>5800.00</b>	<b>177,00</b>

**Composition de douilles - L 75 mm  
Doppenset - L 75 mm** **14 pièces  
14-delig**

⬡ 10 12 13 14 15 17 19 21 22 23 24 27 30 32 mm

Code	Ref.	€
1825054	<b>5560.00</b>	<b>105,00</b>

**Composition de douilles TORX  
Doppenset TORX** **16 pièces  
16-delig**

⬢ E10 E11 E12 E14 E16 E18 E22 E24  
 ⬢ T30 T40 T45 T50 T55 T60 T70

Code	Ref.	€
1852035	<b>5530.00</b>	<b>80,00</b>



**Composition de douilles à choc** **12 pièces**  
**Impact-doppenset** **12-delig**

⬡ 10 11 12 13 14 15 16 17 19 21 22 24 mm

Code	Ref.	€
1852051	<b>5540.00</b>	<b>51,00</b>



**Composition de douilles à choc - L 85 mm** **12 pièces**  
**Impact-doppenset - L 85 mm** **12-delig**

⬡ 10 11 12 13 14 15 16 17 19 21 22 24 mm

Code	Ref.	€
1852078	<b>5565.00</b>	<b>80,00</b>



**Compositions de douilles pour boulons de voiture**  
**Impact-doppensets voor wielenbouten**

⬢ 17 19 21 mm

Code	Ref.	€
1854178	<b>5575.00</b>	<b>32,00</b>





### Cliquet réversible Omschakelbare ratel

Code	Ref.	↳ mm ↲	€
1683500	<b>8170.00</b>	510	<b>65,00</b>

### Douille 3/4" 6 pans Dop 3/4" 6-kant

ISO 1174  
ISO 1174

Code	Ref.	Ø mm	€
2253410	<b>8100.18</b>	18	<b>7,90</b>
1683276	<b>8100.19</b>	19	<b>7,90</b>
1683292	<b>8100.21</b>	21	<b>7,90</b>
1683306	<b>8100.22</b>	22	<b>7,90</b>
1683314	<b>8100.24</b>	24	<b>7,90</b>
1683322	<b>8100.27</b>	27	<b>8,50</b>
1683330	<b>8100.30</b>	30	<b>9,10</b>
1683349	<b>8100.32</b>	32	<b>9,70</b>
1683357	<b>8100.33</b>	33	<b>10,10</b>
2253429	<b>8100.34</b>	34	<b>11,20</b>
1683365	<b>8100.36</b>	36	<b>11,20</b>
1683373	<b>8100.38</b>	38	<b>11,20</b>
1683381	<b>8100.41</b>	41	<b>13,50</b>
1683403	<b>8100.46</b>	46	<b>14,60</b>
1683411	<b>8100.50</b>	50	<b>16,80</b>
1683438	<b>8100.55</b>	55	<b>20,20</b>
1683446	<b>8100.60</b>	60	<b>23,60</b>



### Douille à choc 3/4" 6 pans Impact-dop 3/4" 6-kant

ISO 1174  
ISO 1174

Code	Ref.	Ø mm	€
1852086	<b>8106.17</b>	17	<b>10,30</b>
1852094	<b>8106.18</b>	18	<b>10,30</b>
1852108	<b>8106.19</b>	19	<b>10,30</b>
1852116	<b>8106.22</b>	22	<b>11,50</b>
1852124	<b>8106.24</b>	24	<b>11,80</b>
1852132	<b>8106.26</b>	26	<b>12,50</b>
1852140	<b>8106.27</b>	27	<b>12,50</b>
1852167	<b>8106.29</b>	29	<b>13,60</b>
1852175	<b>8106.30</b>	30	<b>13,60</b>
1852183	<b>8106.32</b>	32	<b>13,90</b>
1852191	<b>8106.33</b>	33	<b>14,60</b>
1852205	<b>8106.34</b>	34	<b>15,10</b>
1852213	<b>8106.35</b>	35	<b>15,70</b>
1852221	<b>8106.36</b>	36	<b>16,80</b>
1852248	<b>8106.38</b>	38	<b>19,90</b>
1852256	<b>8106.41</b>	41	<b>21,40</b>



### Cardan / Cardangewricht

Code	Ref.	↳ mm ↲	€
1683489	<b>8130.00</b>	100	<b>34,00</b>



### Allonge / Verlengstuk

Code	Ref.	↳ mm ↲	€
1683470	<b>8150.20</b>	200	<b>15,70</b>
1683462	<b>8150.40</b>	400	<b>25,40</b>



### Poignée coulissante / Schuifgreep

Code	Ref.	↳ mm ↲	€
1683454	<b>8140.00</b>	450	<b>27,00</b>



### Composition de douilles & accessoires Doppenset met toebehoren

**14 pièces  
14-delig**

Ø 22 24 27 30 32 36 38 41 46 50 mm  
Allonges / Verlengstukken: 200 mm - 400 mm  
Poignée coulissante / Schuifgreep

Code	Ref.	€
1683268	<b>8100.00</b>	<b>290,00</b>



**Avec réglage fin  
Met fijne instelling**

0.1 Nm	4900.025
0.25 Nm	6900.070
0.5 Nm	5900.100
1.0 Nm	5900.200 5900.300
	8900.400 8900.550



**Clés dynamométriques 5-550 Nm**

- Clés dynamométriques réglables avec carré conducteur et fonction cliquet intégrée pour le serrage contrôlé à gauche et à droite
- Tolérance  $\pm 3\%$  par rapport à l'échelle graduée
- Double lecture Nm-lb.ft
- Certificat de contrôle selon DIN EN ISO 6789
- Livré avec trousse de protection

**Momentsleutels 5-550 Nm**

- Verstelbare momentsleutel met vierkantaandrijver en geïntegreerde ratelfunctie voor het gecontroleerde vastdraaien, links en rechts
- Nauwkeurigheid  $\pm 3\%$  tolerantie van de ingestelde schaalwaarde
- Goede aflezing dubbelschaal Nm-lb.ft
- Inclusief testcertificaat volgens DIN



Code	Ref.	Description / Beschrijving	■	Nm	↳mm↳	€
2648350	<b>4900.025</b>	tête champignon/paddenstoelkop	1/4"	5-25	285	<b>140,00</b>
2648369	<b>6900.070</b>	tête champignon/paddenstoelkop	3/8"	14-70	350	<b>140,00</b>
2648377	<b>5900.100</b>	tête champignon/paddenstoelkop	1/2"	200-100	395	<b>140,00</b>
2648393	<b>5900.200</b>	tête champignon/paddenstoelkop	1/2"	40-200	485	<b>140,00</b>
2648407	<b>5900.300</b>	tête champignon/paddenstoelkop	1/2"	60-300	575	<b>148,00</b>
2648414	<b>8900.400</b>	carré réversible/omkeerbare aandrijving	3/4"	80-400	685	<b>247,00</b>
1648423	<b>8900.550</b>	carré réversible/omkeerbare aandrijving	3/4"	110-550	955	<b>388,00</b>

**Tournevis pour vis à fente**  
**Schroevendraaier tbv zaagsnede schroeven**

Code	Ref.	⊖	mm	mm	€
2251256	<b>3600.030</b>	0.5 x 3.0	75	145	<b>3,00</b>
2251264	<b>3600.040</b>	0.8 x 4.0	100	170	<b>3,20</b>
2251272	<b>3600.055</b>	1.0 x 5.5	100	210	<b>3,90</b>
2251280	<b>3600.065</b>	1.2 x 6.5	150	260	<b>4,80</b>
2251299	<b>3600.080</b>	1.2 x 8.0	150	270	<b>5,80</b>
2251302	<b>3600.100</b>	1.6 x 10.0	200	320	<b>7,10</b>

**Tournevis STUBBY pour vis à fente**  
**Schroevendraaier STUBBY tbv zaagsnede schroeven**

Code	Ref.	⊖	mm	mm	€
2251353	<b>3620.040</b>	0.8 x 4.0	38	63	<b>4,10</b>
2251361	<b>3620.065</b>	1.2 x 6.5	38	63	<b>4,10</b>

**Tournevis pour vis Phillips**  
**Schroevendraaier tbv Phillips schroeven**

Code	Ref.	⊕	mm	mm	€
2251396	<b>3630.000</b>	Ph0	75	145	<b>3,00</b>
2251426	<b>3630.010</b>	Ph1	100	210	<b>3,80</b>
2251434	<b>3630.020</b>	Ph2	100	210	<b>4,30</b>
2251442	<b>3630.030</b>	Ph3	150	270	<b>6,00</b>

**Tournevis STUBBY pour vis Phillips**  
**Schroevendraaier STUBBY tbv Phillips schroeven**

Code	Ref.	⊕	mm	mm	€
2251493	<b>3650.010</b>	Ph1	38	63	<b>4,10</b>
2251507	<b>3650.020</b>	Ph2	38	63	<b>4,10</b>

**Tournevis pour vis Pozidriv**  
**Schroevendraaier tbv Pozidriv schroeven**

Code	Ref.	⊕	mm	mm	€
2251450	<b>3640.000</b>	Pz0	75	145	<b>3,00</b>
2251469	<b>3640.010</b>	Pz1	100	210	<b>3,80</b>
2251477	<b>3640.020</b>	Pz2	100	210	<b>4,30</b>
2251485	<b>3640.030</b>	Pz3	150	270	<b>6,00</b>

**Tournevis STUBBY pour vis Pozidriv**  
**Schroevendraaier tbv Pozidriv schroeven**

Code	Ref.	⊕	mm	mm	€
2251515	<b>3660.010</b>	Pz1	38	63	<b>4,10</b>
2251523	<b>3660.020</b>	Pz2	38	63	<b>4,10</b>

**Tournevis STUBBY pour vis Torx**  
**Schroevendraaier tbv Torx schroeven**

Code	Ref.	⊕	mm	mm	€
2251531	<b>3690.060</b>	T 6	75	145	<b>3,30</b>
2251558	<b>3690.070</b>	T 7	75	145	<b>3,30</b>
2251566	<b>3690.080</b>	T 8	75	145	<b>3,30</b>
2251574	<b>3690.090</b>	T 9	75	145	<b>3,30</b>
2251582	<b>3690.100</b>	T10	100	210	<b>4,20</b>
2251590	<b>3690.150</b>	T15	100	210	<b>4,20</b>
2251604	<b>3690.200</b>	T20	100	210	<b>4,20</b>
2251612	<b>3690.250</b>	T25	100	210	<b>4,70</b>
2251620	<b>3690.270</b>	T27	100	210	<b>4,70</b>
2251639	<b>3690.300</b>	T30	100	210	<b>4,70</b>
2251647	<b>3690.400</b>	T40	100	210	<b>4,90</b>
2251655	<b>3690.450</b>	T45	100	210	<b>7,50</b>



**Jeu de tournevis  
Schroevendraaierset**

**6 pièces  
6-delig**

Composition / Inhoud:  
 ⊖ 3 5.5 6.5 mm  
 ⊕ Ph0 Ph1 Ph2

Code	Ref.	€
2251671	<b>3603.000</b>	<b>21,50</b>



**Jeu de tournevis  
Schroevendraaierset**

**6 pièces  
6-delig**

Composition / Inhoud:  
 ⊖ 3 5.5 6.5 mm  
 ⊕ Pz0 Pz1 Pz2

Code	Ref.	€
2251698	<b>3604.000</b>	<b>21,50</b>



**Jeu de tournevis  
Schroevendraaierset**

**6 pièces  
6-delig**

Composition / Inhoud:  
 ⊕ T10 T15 T20 T25 T30 T40

Code	Ref.	€
2251701	<b>3690.000</b>	<b>25,00</b>



**Contrôleur de tension - max 250V  
Spanningzoeker - max 250V**

Code	Ref.	mm		€
1695584	<b>3710.03</b>	3.0	135	<b>2,80</b>



**Contrôleur de tension - max 250V  
Spanningzoeker - max 250V**

Code	Ref.	mm		€
2254328	<b>3711.030</b>	3.0	135	<b>2,80</b>

**Clés INBUS / Stiftsleutels INBUS**

Code	Ref.	mm	L <sub>1</sub>	L <sub>2</sub>	€
1671359	<b>3720.02</b>	2.0	50	16	<b>0,50</b>
1671391	<b>3720.25</b>	2.5	56	18	<b>0,50</b>
1671448	<b>3720.03</b>	3.0	63	20	<b>0,60</b>
1671685	<b>3720.04</b>	4.0	70	25	<b>0,60</b>
1671693	<b>3720.05</b>	5.0	80	28	<b>0,70</b>
1671707	<b>3720.06</b>	6.0	90	32	<b>0,90</b>
1671715	<b>3720.07</b>	7.0	95	34	<b>1,10</b>
1671723	<b>3720.08</b>	8.0	100	36	<b>1,45</b>
1670832	<b>3720.10</b>	10.0	105	40	<b>2,10</b>

**Clés INBUS à tête sphérique  
Stiftsleutels INBUS met kogelkop**

Code	Ref.	mm	L <sub>1</sub>	L <sub>2</sub>	€
1695614	<b>3730.02</b>	2.0	100	16	<b>0,60</b>
1695703	<b>3730.25</b>	2.5	112	18	<b>0,75</b>
1695630	<b>3730.03</b>	3.0	126	20	<b>0,90</b>
1695649	<b>3730.04</b>	4.0	140	25	<b>1,10</b>
1695657	<b>3730.05</b>	5.0	160	28	<b>1,40</b>
1695665	<b>3730.06</b>	6.0	180	32	<b>1,75</b>
1695673	<b>3730.08</b>	8.0	200	36	<b>2,55</b>
1695681	<b>3730.10</b>	10.0	224	40	<b>3,90</b>

**Clés TORX / Stiftsleutels TORX**

Code	Ref.		L <sub>1</sub>	L <sub>2</sub>	€
1695746	<b>3740.07</b>	T 7	48	16	<b>0,90</b>
1695770	<b>3740.08</b>	T 8	48	16	<b>0,90</b>
1695797	<b>3740.09</b>	T 9	48	16	<b>0,90</b>
1695819	<b>3740.10</b>	T10	51	17	<b>0,90</b>
1695827	<b>3740.15</b>	T15	54	18	<b>0,95</b>
1695835	<b>3740.20</b>	T20	57	19	<b>0,95</b>
1695843	<b>3740.25</b>	T25	60	20	<b>1,45</b>
1695851	<b>3740.27</b>	T27	64	21	<b>1,45</b>
1695886	<b>3740.30</b>	T30	70	24	<b>1,55</b>
1695894	<b>3740.40</b>	T40	76	26	<b>1,95</b>

**Jeu de clés INBUS  
Stiftsleutelset INBUS**
**8 pièces  
8-Delig**

 Composition / Inhoud:  
 ● 2 2.5 3 4 5 6 8 10 mm

Code	Ref.	€
1671324	<b>3720.00</b>	<b>8,20</b>

**Jeu de clés INBUS à tête sphérique  
Stiftsleutelset INBUS met kogelkop**
**9 pièces  
9-Delig**

 Composition / Inhoud:  
 ● 1.5 2 2.5 3 4 5 6 8 10 mm

Code	Ref.	€
1695592	<b>3730.00</b>	<b>13,70</b>

**Jeu de clés TORX  
Stiftsleutelset TORX**
**7 pièces  
7-Delig**

 Composition / Inhoud:  
 ● T10 T15 T20 T25 T27 T30

Code	Ref.	€
1695711	<b>3740.00</b>	<b>14,50</b>



**Clés mâles coudées INBUS avec poignée T**  
**Haakse stiftsleutel INBUS met T-greep**

Code	Ref.	mm	€
2250942	<b>3810.025</b>	2.5	<b>3,80</b>
2250950	<b>3810.030</b>	3.0	<b>4,10</b>
2250969	<b>3810.040</b>	4.0	<b>4,50</b>
2250977	<b>3810.050</b>	5.0	<b>4,90</b>
2250985	<b>3810.060</b>	6.0	<b>5,70</b>
2250993	<b>3810.080</b>	8.0	<b>6,20</b>
2251019	<b>3810.100</b>	10.0	<b>7,80</b>

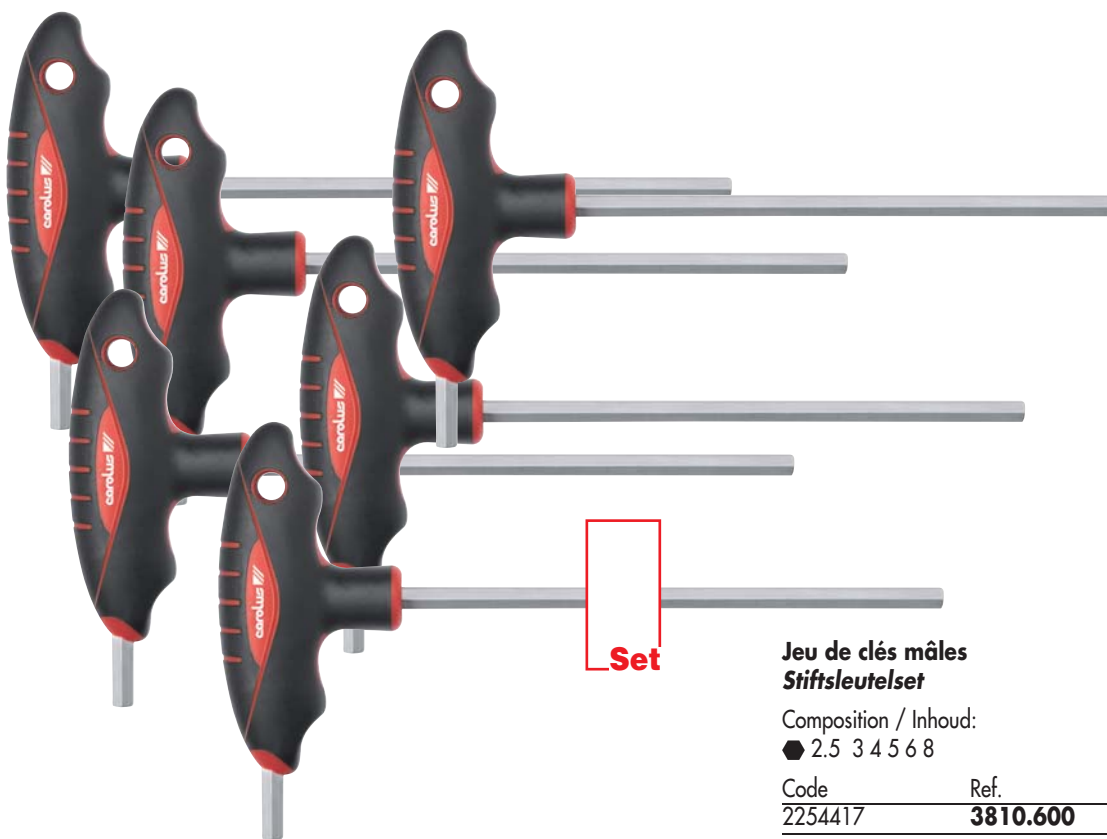

**Set**

**Jeu de clés mâles**  
**Stiftsleutelset**

**6 pièces**  
**6-delig**

Composition / Inhoud:  
 ● 2.5 3 4 5 6 8

Code	Ref.	€
2254417	<b>3810.600</b>	<b>29,70</b>



**Magnétiseur/démagnétiseur pour bits et tournevis**  
**Demagnetiseerblok voor bits en schroevendraaiers**

Code	Ref.	mm	€
1797921	<b>3600.00</b>	52 x 50 - H 26	<b>15,10</b>

Répondant à la norme VDE 0682 chapitre 201 et à la norme EN/IEC 60900  
 Voldoet aan de norm VDE 0682 deel 201 en de norm EN/IEC 60900



**Tournevis pour vis à fente**  
**Schroevendraaier tbv zaagsnede schroeven**

Code	Ref.	mm $\pm$ $\leftarrow$	mm $\pm$ $\rightarrow$	€
2250632	<b>3675.025</b>	0.4	2.5	<b>3,80</b>
2250640	<b>3675.030</b>	0.5	3.0	<b>4,00</b>
2250659	<b>3675.040</b>	0.8	4.0	<b>4,70</b>
2250667	<b>3675.055</b>	1.0	5.5	<b>5,20</b>



**Tournevis pour vis Philips**  
**Schroevendraaier tbv Phillips schroeven**

Code	Ref.	$\oplus$	€
2250675	<b>3685.01</b>	Ph1	<b>4,90</b>
2250683	<b>3685.02</b>	Ph2	<b>5,70</b>



**Tournevis pour vis Pozidriv**  
**Schroevendraaier tbv Pozidriv schroeven**

Code	Ref.	$\oplus$	€
2256819	<b>3686.01</b>	Pz1	<b>4,90</b>
2256827	<b>3686.02</b>	Pz2	<b>5,70</b>



**Pince universelle**  
**Combinatietang**

Code	Ref.	mm $\rightarrow$	€
2250543	<b>2930.180</b>	180	<b>20,40</b>
2250551	<b>2930.200</b>	200	<b>21,60</b>



**Pince coupante diagonale**  
**Zijsnijtang amerikaans model**

Code	Ref.	mm $\rightarrow$	€
2250423	<b>2945.180</b>	180	<b>20,40</b>



**Pince téléphone à bcs droits**  
**Telefontang met rechte bekken**

Code	Ref.	mm $\rightarrow$	€
2250586	<b>2950.200</b>	200	<b>21,60</b>



**Pince téléphone à bcs coudés**  
**Telefontang met gebogen bekken**

Code	Ref.	mm $\rightarrow$	€
2250608	<b>2951.200</b>	200	<b>22,60</b>

## OUTILS 1000 V - GEREEDSCHAP

Répondant à la norme VDE 0682 chapitre 201 et à la norme EN/IEC 60900  
Voldoet aan de norm VDE 0682 deel 201 en de norm EN/IEC 60900

**carolus**

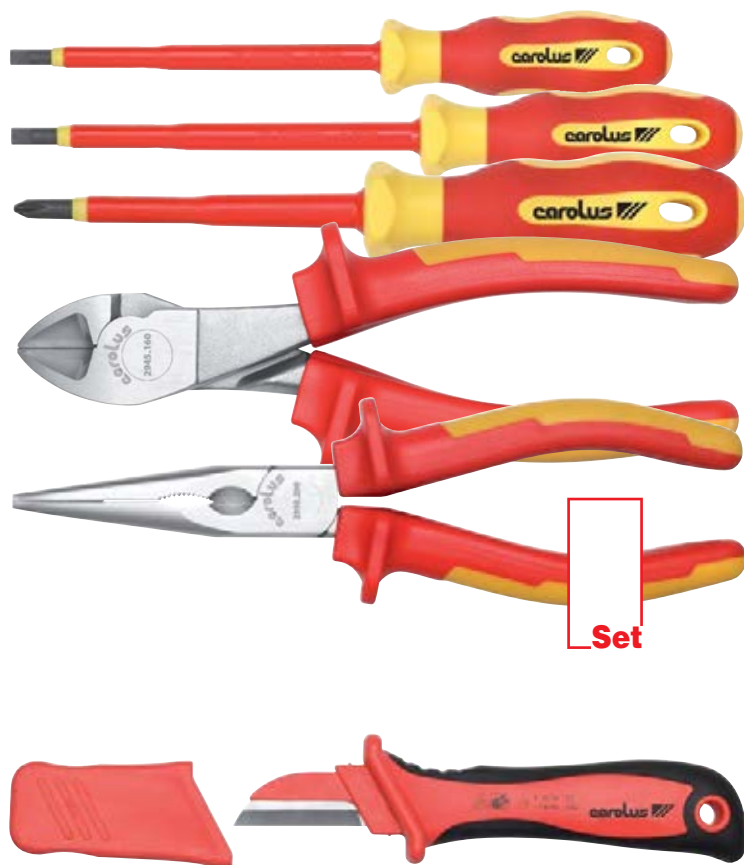

### Jeu de 5 outils VDE VDE gereedschapset 5-delig

Pince coupante 160 mm / Zijsnijtang 160 mm  
Pince telephone 200 mm / Telefoontang 200 mm  
Tournevis / Schroevendraaier:  $\ominus$  3 5.5 mm  
Tournevis / Schroevendraaier:  $\oplus$  Ph2

Code	Ref.	€
2254387	<b>2936.500</b>	<b>58,00</b>

### Couteau de câble

- *Lame en acier inoxydable*
- *Manche ergonomique multi matière*

### Kabelmes

- *Mesje uit roestvrij staal*
- *Ergonomische meercomponenten handgreep*

Code	Ref.	€
2250527	<b>9520.00</b>	<b>12,50</b>



### Contrôleur de tension 6-400 V Spanningzoeker 6-400 V

Code	Ref.	€
2256932	<b>3715.00</b>	<b>33,50</b>

**USH offre un large éventail de bits disponibles en trois classes de qualité:**
**INDUSTRY**

Alliage d'acier (WX 73, mat n° 1.2381) aux qualités excédant la norme DIN de 80 %

**ISOTIN**

A revêtement multicouche de nitrure de titane pour une dureté de 3.000 HV (bit TIN standard: 2.500 HV), ce qui implique une plus longue durée de vie et un couple de 30 % supérieur à la norme.

**DIATIN**

A revêtement de céramique sur une couche de carbure de titane, ce procédé de fabrication offrant, outre une très grande dureté, une réduction drastique de l'effet CAM-OUT et conséquemment, une augmentation du couple de 80 % par rapport à la norme.

**CONDITIONNEMENT:**

Deux types de conditionnement sont proposés:

- en boîte de 100 pièces
- en boîte à suspendre de 5 (USE), 10 (USG) ou 50 (USP) pièces, avec étiquette mentionnant la référence, la quantité, et le code EAN

**USH biedt een brede waaier bits aan, beschikbaar in drie kwaliteitsklassen:**
**INDUSTRY**

*Staallegering (WX 73, mat nr. 1.2381) met kwaliteiten die de DIN norm met 80 % overschrijden.*

**ISOTIN**

*Met bekleding van meerdere lagen titaannitrure voor een hardheid van 3000 HV (standaard TIN bit: 2500 HV) met als gevolg een langere levensduur en een koppel van 30 % boven de norm.*

**DIATIN**

*Met bekleding van keramiek bovenop een laag titaancarbid, biedt dit fabricatie-procédé naast een zeer grote hardheid ook een drastische vermindering van het CAM-OUT effect en bijgevolg ook een stijging van koppel van 80 % ten opzichte van de norm.*

**CONDITIONERING:**



*Er worden 2 types verpakking voorgesteld:*

- *In doosje van 100 stuks*
- *In een ophangdoosje per 5 (USE), 10 (USG) of 50 (USP) stuks, voorzien van een etiket met vermelding van referentie, hoeveelheid en EAN code*



## BITS DIATIN - SUPERIOR QUALITY - THE NEW GENERATION



	REF.	Dimensions / Afmetingen	€
 1/4" - 25 mm	<b>USE 32.341</b>	Ph 1	<b>10,80</b>
	<b>USE 32.342</b>	Ph 2	<b>10,80</b>
	<b>USE 32.344</b>	Ph 3	<b>10,80</b>
 1/4" - 25 mm	<b>USE 32.360</b>	Pz 1	<b>10,80</b>
	<b>USE 32.361</b>	Pz 2	<b>10,80</b>
	<b>USE 32.362</b>	Pz 3	<b>10,80</b>
 1/4" - 25 mm	<b>USE 32.393</b>	Tx 10	<b>14,20</b>
	<b>USE 32.394</b>	Tx 15	<b>14,20</b>
	<b>USE 32.395</b>	Tx 20	<b>14,20</b>
	<b>USE 32.396</b>	Tx 25	<b>14,20</b>
	<b>USE 32.397</b>	Tx 27	<b>14,20</b>
	<b>USE 32.398</b>	Tx 30	<b>14,20</b>
	<b>USE 32.399</b>	Tx 40	<b>14,20</b>

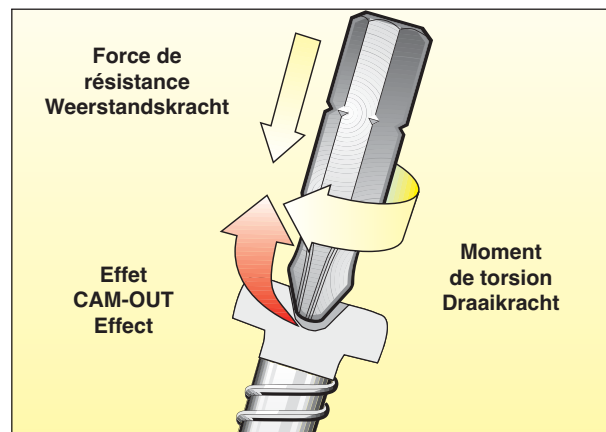





**Conditionnement / Verpakking:**  
**USE = 5 pcs/st**

**Pour d'autres conditionnements: nous consulter**  
**Andere verpakking: op aanvraag**

## BITS ISOTIN® - TOP QUALITY - DURETÉ / HARDHEID : 95 HRC

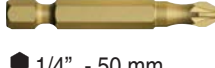

	REF.	Dimensions / Afmetingen	€
 1/4" - 25 mm	<b>USG 22.341</b>	Ph 1	<b>10,50</b>
	<b>USG 22.342</b>	Ph 2	<b>10,50</b>
	<b>USG 22.344</b>	Ph 3	<b>10,50</b>
 1/4" - 50 mm	<b>USE 213.621</b>	Ph 1	<b>14,00</b>
	<b>USE 213.622</b>	Ph 2	<b>14,00</b>
	<b>USE 213.623</b>	Ph 3	<b>14,00</b>
 1/4" - 25 mm	<b>USG 22.360</b>	Pz 1	<b>10,50</b>
	<b>USG 22.361</b>	Pz 2	<b>10,50</b>
	<b>USG 22.362</b>	Pz 3	<b>10,50</b>
 1/4" - 50 mm	<b>USE 213.630</b>	Pz 1	<b>14,00</b>
	<b>USE 213.631</b>	Pz 2	<b>14,00</b>
	<b>USE 213.632</b>	Pz 3	<b>14,00</b>
 1/4" - 25 mm	<b>USG 22.393</b>	Tx 10	<b>14,00</b>
	<b>USG 22.394</b>	Tx 15	<b>14,00</b>
	<b>USG 22.395</b>	Tx 20	<b>14,00</b>
	<b>USG 22.396</b>	Tx 25	<b>14,00</b>
	<b>USG 22.397</b>	Tx 27	<b>14,00</b>
	<b>USG 22.398</b>	Tx 30	<b>14,00</b>
	<b>USG 22.399</b>	Tx 40	<b>14,00</b>





**Conditionnement / Verpakking:**  
**USE = 5 pcs/st**  
**USG = 10 pcs/st**



















**Conditionnement / Verpakking:** — = 1 pce/st  
**USE = 5 pces/st**  
**USG = 10 pces/st**  
**USP = 50 pces/st**

**Pour d'autres conditionnements: nous consulter**  
**Andere verpakking: op aanvraag**

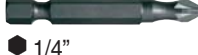



	↔ mm	REF.	Dimensions / Afmetingen	€
	25	<b>USE 112.303</b>	0,6x4,5	<b>3,50</b>
	25	<b>USE 112.305</b>	0,8x5,5	<b>3,50</b>
	25	<b>USE 112.307</b>	1,2x6,5	<b>3,50</b>
	25	<b>USE 112.309</b>	1,6x8,0	<b>4,20</b>
● 1/4"				
	50	<b>113.602</b>	0,5x3,0	<b>2,60</b>
	50	<b>113.603</b>	0,6x4,5	<b>2,60</b>
	50	<b>113.606</b>	1,0x5,5	<b>2,60</b>
● 1/4"				

	↔ mm	REF.	Dimensions / Afmetingen	€
	25	<b>USG 12.341</b>	Ph 1	<b>4,20</b>
	25	<b>USG 12.342</b>	Ph 2	<b>4,20</b>
	25	<b>USG 12.343</b>	Ph 3	<b>4,20</b>
	32	<b>USE 12.045</b>	Ph 4	<b>8,30</b>
● 1/4"				
	25	<b>USP 12.342</b>	Ph 2	<b>19,00</b>
	25	<b>USP 12.343</b>	Ph 3	<b>19,00</b>
● 1/4"				
	50	<b>13.621</b>	Ph 1	<b>1,25</b>
	50	<b>13.622</b>	Ph 2	<b>1,25</b>
	50	<b>13.623</b>	Ph 3	<b>1,25</b>
● 1/4"				
	50	<b>USG 13.621</b>	Ph 1	<b>11,50</b>
	50	<b>USG 13.622</b>	Ph 2	<b>11,50</b>
	50	<b>USG 13.623</b>	Ph 3	<b>11,50</b>
● 1/4"				
	70	<b>135.021</b>	Ph 1	<b>2,10</b>
	70	<b>135.022</b>	Ph 2	<b>2,10</b>
	70	<b>135.023</b>	Ph 3	<b>2,10</b>
● 1/4"				
	90	<b>136.021</b>	Ph 1	<b>2,95</b>
	90	<b>136.022</b>	Ph 2	<b>2,95</b>
	90	<b>136.023</b>	Ph 3	<b>2,95</b>
● 1/4"				
	110	<b>137.021</b>	Ph 1	<b>3,90</b>
	110	<b>137.022</b>	Ph 2	<b>3,90</b>
	110	<b>137.023</b>	Ph 3	<b>3,90</b>
● 1/4"				
	150	<b>139.021</b>	Ph 1	<b>6,00</b>
	150	<b>139.022</b>	Ph 2	<b>6,00</b>
	150	<b>139.023</b>	Ph 3	<b>6,00</b>
● 1/4"				

	↔ mm	REF.	Dimensions / Afmetingen	€
	25	<b>USG 12.360</b>	Pz 1	<b>4,20</b>
	25	<b>USG 12.361</b>	Pz 2	<b>4,20</b>
	25	<b>USG 12.362</b>	Pz 3	<b>4,20</b>
	32	<b>USE 12.063</b>	Pz 4	<b>8,30</b>
● 1/4"				
	25	<b>USP 12.361</b>	Pz 2	<b>19,00</b>
	25	<b>USP 12.362</b>	Pz 3	<b>19,00</b>
● 1/4"				
	50	<b>13.630</b>	Pz 1	<b>1,25</b>
	50	<b>13.631</b>	Pz 2	<b>1,25</b>
	50	<b>13.632</b>	Pz 3	<b>1,25</b>
● 1/4"				
	50	<b>USG 13.630</b>	Pz 1	<b>11,50</b>
	50	<b>USG 13.631</b>	Pz 2	<b>11,50</b>
	50	<b>USG 13.632</b>	Pz 3	<b>11,50</b>
● 1/4"				
	70	<b>135.030</b>	Pz 1	<b>2,10</b>
	70	<b>135.031</b>	Pz 2	<b>2,10</b>
	70	<b>135.032</b>	Pz 3	<b>2,10</b>
● 1/4"				
	90	<b>136.030</b>	Pz 1	<b>2,95</b>
	90	<b>136.031</b>	Pz 2	<b>2,95</b>
	90	<b>136.032</b>	Pz 3	<b>2,95</b>
● 1/4"				
	110	<b>137.030</b>	Pz 1	<b>3,90</b>
	110	<b>137.031</b>	Pz 2	<b>3,90</b>
	110	<b>137.032</b>	Pz 3	<b>3,90</b>
● 1/4"				
	150	<b>139.030</b>	Pz 1	<b>6,00</b>
	150	<b>139.031</b>	Pz 2	<b>6,00</b>
	150	<b>139.032</b>	Pz 3	<b>6,00</b>
● 1/4"				

	↔ mm	REF.	Dimensions / Afmetingen	€
	25	<b>USG 12.027</b>	Nr. 1	<b>8,70</b>
	25	<b>USG 12.028</b>	Nr. 2	<b>8,70</b>
	25	<b>USG 12.029</b>	Nr. 3	<b>8,70</b>
● 1/4" Robertson				

	↔ mm	REF.	Dimensions / Afmetingen	€
	50	<b>USE 13.017</b>	Nr. 1	<b>17,40</b>
	50	<b>USE 13.018</b>	Nr. 2	<b>17,40</b>
	50	<b>USE 13.019</b>	Nr. 3	<b>17,40</b>
● 1/4" Robertson				



↔ mm	REF.	Dimensions / Afmetingen	€
25	<b>USE 12.088</b>	Tx 5	<b>4,20</b>
25	<b>USE 12.089</b>	Tx 6	<b>4,20</b>
25	<b>USE 12.090</b>	Tx 7	<b>4,20</b>
25	<b>USE 12.091</b>	Tx 8	<b>4,20</b>
25	<b>USE 12.092</b>	Tx 9	<b>4,20</b>

● 1/4" ★ Torx®



25	<b>USG 12.393</b>	Tx 10	<b>7,50</b>
25	<b>USG 12.394</b>	Tx 15	<b>7,50</b>
25	<b>USG 12.395</b>	Tx 20	<b>7,50</b>
25	<b>USG 12.396</b>	Tx 25	<b>7,50</b>
25	<b>USG 12.397</b>	Tx 27	<b>7,50</b>
25	<b>USG 12.398</b>	Tx 30	<b>7,50</b>
25	<b>USG 12.399</b>	Tx 40	<b>7,50</b>

● 1/4" ★ Torx® TSI



50	<b>103.654</b>	Tx 10	<b>2,60</b>
50	<b>103.655</b>	Tx 15	<b>2,60</b>
50	<b>103.656</b>	Tx 20	<b>2,60</b>
50	<b>103.657</b>	Tx 25	<b>2,60</b>
50	<b>103.658</b>	Tx 27	<b>2,60</b>
50	<b>103.659</b>	Tx 30	<b>2,60</b>
50	<b>103.660</b>	Tx 40	<b>2,60</b>

● 1/4" ★ Torx®



70	<b>135.093</b>	Tx 10	<b>3,80</b>
70	<b>135.094</b>	Tx 15	<b>3,80</b>
70	<b>135.095</b>	Tx 20	<b>3,80</b>
70	<b>135.096</b>	Tx 25	<b>3,80</b>
70	<b>135.097</b>	Tx 27	<b>3,80</b>
70	<b>135.098</b>	Tx 30	<b>3,80</b>
70	<b>135.099</b>	Tx 40	<b>3,80</b>

● 1/4" ★ Torx®



90	<b>136.093</b>	Tx 10	<b>3,90</b>
90	<b>136.094</b>	Tx 15	<b>3,90</b>
90	<b>136.095</b>	Tx 20	<b>3,90</b>
90	<b>136.096</b>	Tx 25	<b>3,90</b>
90	<b>136.097</b>	Tx 27	<b>3,90</b>
90	<b>136.098</b>	Tx 30	<b>3,90</b>
90	<b>136.099</b>	Tx 40	<b>3,90</b>

● 1/4" ★ Torx®



110	<b>137.093</b>	Tx 10	<b>4,20</b>
110	<b>137.094</b>	Tx 15	<b>4,20</b>
110	<b>137.095</b>	Tx 20	<b>4,20</b>
110	<b>137.096</b>	Tx 25	<b>4,20</b>
110	<b>137.097</b>	Tx 27	<b>4,20</b>
110	<b>137.098</b>	Tx 30	<b>4,20</b>
110	<b>137.099</b>	Tx 40	<b>4,20</b>

● 1/4" ★ Torx®



150	<b>139.093</b>	Tx 10	<b>6,00</b>
150	<b>139.094</b>	Tx 15	<b>6,00</b>
150	<b>139.095</b>	Tx 20	<b>6,00</b>
150	<b>139.096</b>	Tx 25	<b>6,00</b>
150	<b>139.097</b>	Tx 27	<b>6,00</b>
150	<b>139.098</b>	Tx 30	<b>6,00</b>
150	<b>139.099</b>	Tx 40	<b>6,00</b>

● 1/4" ★ Torx®



↔ mm	REF.	Dimensions / Afmetingen	€
25	<b>12.970</b>	2,5 mm K	<b>2,50</b>
25	<b>12.971</b>	3,0 mm K	<b>2,50</b>
25	<b>12.972</b>	4,0 mm K	<b>2,50</b>
25	<b>12.973</b>	5,0 mm K	<b>2,50</b>
25	<b>12.974</b>	6,0 mm K	<b>2,50</b>

● 1/4" ○



50	<b>13.942</b>	2,5 mm K	<b>4,20</b>
50	<b>13.943</b>	3,0 mm K	<b>4,20</b>
50	<b>13.944</b>	4,0 mm K	<b>4,20</b>
50	<b>13.945</b>	5,0 mm K	<b>4,20</b>
50	<b>13.946</b>	8,0 mm K	<b>4,20</b>

● 1/4" ○



↔ mm	REF.	Dimensions / Afmetingen	€
25	<b>USE 12.293</b>	Tx 10 Ta	<b>7,50</b>
25	<b>USE 12.294</b>	Tx 15 Ta	<b>7,50</b>
25	<b>USE 12.295</b>	Tx 20 Ta	<b>7,50</b>
25	<b>USE 12.296</b>	Tx 25 Ta	<b>7,50</b>
25	<b>USE 12.297</b>	Tx 27 Ta	<b>7,50</b>
25	<b>USE 12.298</b>	Tx 30 Ta	<b>7,50</b>
25	<b>USE 12.299</b>	Tx 40 Ta	<b>7,50</b>

● 1/4" ★ Tamper



↔ mm	REF.	Dimensions / Afmetingen	€
25	<b>USE 12.069</b>	2,0 mm	<b>4,40</b>
25	<b>USE 12.070</b>	2,5 mm	<b>4,40</b>
25	<b>USE 12.071</b>	3,0 mm	<b>4,20</b>
25	<b>USE 12.072</b>	4,0 mm	<b>4,20</b>
25	<b>USE 12.073</b>	5,0 mm	<b>4,20</b>
25	<b>USE 12.074</b>	6,0 mm	<b>4,20</b>
25	<b>USE 12.075</b>	7,0 mm	<b>6,60</b>
25	<b>USE 12.076</b>	8,0 mm	<b>6,60</b>
25	<b>USE 12.077</b>	10,0 mm	<b>12,80</b>

● 1/4" ○



↔ mm	REF.	Dimensions / Afmetingen	€
50	<b>13.041</b>	2,0 mm	<b>2,80</b>
50	<b>13.042</b>	2,5 mm	<b>2,80</b>
50	<b>13.043</b>	3,0 mm	<b>2,80</b>
50	<b>13.044</b>	4,0 mm	<b>2,80</b>
50	<b>13.045</b>	5,0 mm	<b>2,80</b>
50	<b>13.046</b>	6,0 mm	<b>2,80</b>
50	<b>13.047</b>	7,0 mm	<b>3,00</b>
50	<b>13.048</b>	8,0 mm	<b>3,20</b>

● 1/4" ○

**BITS INDUSTRY HIGH QUALITY**

5/16"



↔ mm	REF.	Dimensions / Afmetingen	€
41	<b>112.513</b>	0,8x4,0	<b>1,80</b>
41	<b>112.514</b>	0,8x5,5	<b>1,80</b>
41	<b>112.516</b>	1,2x6,5	<b>1,80</b>
41	<b>112.518</b>	1,6x8,0	<b>2,00</b>
41	<b>112.519</b>	1,6x10,0	<b>3,00</b>
41	<b>112.520</b>	2,0x12,0	<b>3,70</b>

● 5/16" ○



32	<b>12.541</b>	Ph 1	<b>1,15</b>
32	<b>12.542</b>	Ph 2	<b>1,15</b>
32	<b>12.544</b>	Ph 3	<b>1,15</b>
38	<b>12.545</b>	Ph 4	<b>2,60</b>

● 5/16" ⊕



32	<b>12.560</b>	Pz 1	<b>1,15</b>
32	<b>12.561</b>	Pz 2	<b>1,15</b>
32	<b>12.562</b>	Pz 3	<b>1,15</b>
38	<b>12.563</b>	Pz 4	<b>2,60</b>

● 5/16" ⊕



35	<b>12.596</b>	Tx 25	<b>3,30</b>
35	<b>12.598</b>	Tx 30	<b>3,30</b>
35	<b>12.599</b>	Tx 40	<b>3,30</b>
35	<b>12.600</b>	Tx 45	<b>3,30</b>
35	<b>12.601</b>	Tx 50	<b>3,40</b>
35	<b>12.602</b>	Tx 55	<b>3,60</b>

● 5/16" ★ Torx®



30	<b>12.572</b>	4,0 mm	<b>2,60</b>
30	<b>12.573</b>	5,0 mm	<b>2,60</b>
30	<b>12.574</b>	6,0 mm	<b>2,50</b>
30	<b>12.576</b>	8,0 mm	<b>2,70</b>
30	<b>12.577</b>	10,0 mm	<b>3,60</b>

● 5/16" ○



REF.		↳ mm ‹	€
<b>14.009</b>	<b>Poignée Stubby Schroevendraaier Stubby</b>	80	<b>6,80</b>



REF.		↳ mm ‹	€
<b>14.010</b>	<b>Poignée 2-K Schroevendraaier 2-K</b>	130	<b>8,30</b>



REF.		↳ mm ‹	€
<b>14.012</b>	<b>Poignée barre flexible Schroevendraaier met flexibele stang</b>	260	<b>12,50</b>



REF.		↳ mm ‹	€
<b>14.015</b>	<b>Poignée longue lame Schroevendraaier met lange stang</b>	270	<b>11,00</b>

<b>17.015</b>	<b>Modèle identique présenté sur carte Zelfde model op DIY- kaart</b>		<b>11,70</b>
---------------	---	--	--------------



REF.		↳ mm ‹	€
<b>42.020 SB</b>	<b>Tournevis à cliquet Schroevendraaier met ratel 8 bits dans la poignée / 8 bits in handvat Ph1 - Ph2 - Pz1 - Pz2 Tx15 - Tx20 - Tx25 - Tx30</b>	192-267	<b>15,90</b>



<b>14.020D</b>	<b>Modèle identique présentation en display par 12 pièces Zelfde model, los. Per 12 stuks geleverd in display</b>		<b>14,50</b>
----------------	---	--	--------------



REF.		↳ mm ‹	€
<b>14.016</b>	<b>Lame porte-bit avec ailettes Stang bitschroevendraaier</b>	180	<b>7,00</b>

**Adaptateurs QUICKLOCK  
QUICKLOCK Adapters**



□ 1/4"    ○ 1/4"

REF.		↳ mm ‹	€
<b>10.750</b>		30	<b>22,00</b>



□ 3/8"    ○ 1/4"

<b>10.752</b>		43	<b>25,00</b>
---------------	--	----	--------------



□ 1/2"    ○ 1/4"

<b>10.754</b>		50	<b>27,00</b>
---------------	--	----	--------------

Conditionnement - SPLITPACK - Verpakking

**Douille en alliage cuivre-beryllium trempé - Magnétique**  
**Huls uit koper-beryllium legering - Magnetisch**

REF.	↳mm↳	€
10.001	74	21,00

  
 ◻ 1/4" \*   ◼ 1/4"

**Douille en acier inoxydable - Magnétique**  
**Huls uit roestvrijstaal - Magnetisch**

REF.	↳mm↳	€
10.052	74 Ø 9,6	7,00
10.252	74 Ø 11,1	8,00
15.005	58	3,20
15.007	58*	2,60
10.105	100	8,90
10.110	150	9,80
10.115	200	11,00
10.120	250	13,20

  
 ◻ 1/4" \*   ◼ 1/4"

\* Sans bague  
 \* Zonder ring

10.056	70 Ø 9,6	10,80
--------	----------	-------

  
 ◻ 1/4" \*   ◼ 5/16" Desouter

10.060	74 Ø 9,6	10,80
--------	----------	-------

  
 ◻ 1/4" \*   ◼ 5,5 mm Bosch

10.288	78	13,70
--------	----	-------

  
 ◻ 1/4" \*   ◼ 10 mm SDS Plus®

**Porte-Bit non magnétique**  
**Niet magnetische bithouder**

REF.	↳mm↳	€
11.219	74	11,60

  
 ◻ 1/4"   ◯ 10 mm SDS Plus®

Conditionnement - DIY - Verpakking



17.050 € 4,20  
 Douille/Huls 58 mm



17.170 € 9,50  
 SPACER + Ph 2



17.027 € 10,00  
 BIG II



17.043 € 14,00  
 SDS-PLUS



17.450 € 10,00  
 QUICKLOCK

Conditionnement - SPLITPACK - Verpakking

**A profondeur réglable**  
**pour le vissage sur panneaux gyproc**  
**Met verstelbare diepte**  
**voor het aanschroeven op gipsplaten**

**SPACER**

REF.	↳mm↳	€
15.018	72	8,50

  
 + bit Ph2

**Modèle spécialement développé**  
**pour le charpentier**

- Système de changement rapide QUICKLOCK
- Guidage précis de la vis horizontalement ou verticalement, d'une seule main
- La vis est tenue fermement sur le bit grâce à un anneau magnétique additionnel. Elle ne peut ni glisser, ni tomber

**BiG II**



**Model speciaal ontwikkeld voor**  
**de timmerman**

- QUICKLOCK systeem voor snel wisselen
- Nauwkeurige verticale en horizontale geleiding van de schroef, met één hand
- De schroef wordt stevig op de bit gehouden door extra magnetische ring. Ze kan niet vallen of weglipen

REF.	↳mm↳	€
15.490	68	9,10



Display de comptoir sécurisé  
 Beveiligd verkoopdisplay



**QUICKLOCK - FOX**  
**Magnétique - Magnetisch**

Pour un changement rapide du bit, par rétraction de la douille.  
 Le bit «saute» de son logement et peut ainsi être retiré sans effort.

Voor een snelle bitwisseling, door lichte intrekking van de huls.  
 De bit «springt» uit de houder en kan dan gemakkelijk uitgethaald worden.

REF.	↳mm↳	€
10.490	51	9,30

  
 ◻ 1/4"   ◼ 1/4"

10.492	74	11,00
--------	----	-------

  
 ◻ 1/4"   ◼ 1/4"

10.498	80	20,00
--------	----	-------

  
 ◻ 1/4"   ◯ 10 mm SDS Plus®



**ALL-IN-ONE  
POUR BOIS / VOOR HOUT**

**04010** Contenu / Inhoud **€ 26,00**

Forets HSS / Boren HSS 1/4" Ø 3-3.5-4-5-6 mm  
Bits 25 mm Tx10-Tx15-Tx20-Tx25-Tx30  
Bits 50 mm Ph1-Ph2 Pz1-Pz2

Porte-bit 60 mm en acier inoxydable  
Bithouder 60 mm uit roestvrijstaal

Display 10 pces / 10st



**SAFE-BOX 36**

**04900** Contenu / Inhoud **€ 29,00**

Bits 25 mm 2xPh1-3xPh2-2xPh3  
2xPz1-3xPz2-2xPz3  
1xTx10-Tx15-Tx20-Tx25-Tx27-Tx30-Tx40  
1xHex 2.0-2.5-3.0-4.0-5.0-6.0-8.0  
1xFl 4.0-4.5-5.0-5.5-6.0-6.5-8.0

Porte-bit 60 mm en acier inoxydable  
Bithouder 60 mm uit roestvrijstaal

Display 10 pces / 10st



**SQ-BOX**

**04130** Contenu / Inhoud **€ 8,50**

Bits 25 mm 2xPz1 - 2xPz2 - 1xPz3  
1xTx10 - 2xTx15 - 2xTx20  
2xTx25 - 1xTx30 - 1xTx40

Porte-bit 60 mm acier inoxydable  
Bithouder 60 mm uit roestvrijstaal

Boitier avec clip pour ceinture  
Doosje met gordelclip

Display 15 pces / 15 st



**SAFE-BOX 80**

**04920** Contenu / Inhoud **€ 99,00**

Bits 25 mm FL 3.0 - 4.5 - 2x5.5 - 6.5 - 8.0 MM  
PH 0 - 2xPH1 - 5xPH2 - 2xPH3  
2xPz1 - 5xPz2 - 2xPz3  
T05 - T06 - T07 - T08 - T09 - T10 - T15 - T20 - T25 - T27 - T30 - T40  
HEX 2.0 - 2.5 - 3.0 - 4.0 - 5.0 - 6.0 - 7.0 - 8.0 MM  
TRI WING GR1 - GR2 - GR3 - GR4 - GR5  
TORQ SET GR5 - GR6 - GR8 - GR10  
ROBERTSON GR0 - GR1 - GR2 - GR3  
TORX TAMPER Tx10 - Tx15 - Tx20 - Tx25 - Tx30 - Tx40  
HEX TAMPER 3.0 - 4.0 - 5.0 - 6.0  
SPANNER GR4 - GR6 - GR8 - GR10

Porte-bit magnétique FOX / Bithouder FOX  
Poignée porte-bit à cliquet / Bitschroevendraaier met ratel

Display 15 pces / 15 st





**FLAT BOX  
6 BITS  
+ 1 MAGNETIC HOLDER**

REF.	Contenu / Inhoud	HOLDER	€
<b>06000</b>	Ph 1 - Ph 2 - Pz 1 - Pz 2	STANDA(A)RD	<b>6,00</b>
	Fl 0,8 x 5,5 - Fl 1,2 x 6,5		
<b>06005</b>	Ph 1 - Ph 2 - Pz 1 - Pz 2 Tx 20 - Tx 25	STANDA(A)RD	<b>6,00</b>
<b>06040</b>	Ph 1 - Ph 2 - Ph 3 Pz 1 - Pz 2 - Pz 3	STANDA(A)RD	<b>6,00</b>
<b>06020</b>	Tx 10 - Tx 15 - Tx 20 Tx 25 - Tx 30 - Tx 40	STANDA(A)RD	<b>8,00</b>
<b>06025</b>	Tx 10 Ta - Tx 15 Ta - Tx 20 Ta Tx 25 Ta - Tx 30 Ta - Tx 40 Ta	STANDA(A)RD	<b>13,00</b>
<b>06090</b>	HEX 2 - 2,5 - 3 - 4 - 5 - 6 mm INBUS	STANDA(A)RD	<b>8,00</b>

**QUALITY INDUSTRY**

REF.	Contenu / Inhoud	HOLDER	€
<b>06100</b>	Ph 1 - Ph 2 - Pz 1 - Pz 2 Fl 0,8 x 5,5 - Fl 1,2 x 6,5		<b>18,50</b>
<b>06140</b>	Ph 1 - Ph 2 - Ph 3 Pz 1 - Pz 2 - Pz 3		
<b>06120</b>	Tx 10 - Tx 15 - Tx 20 Tx 25 - Tx 30 - Tx 40		<b>18,00</b>

**ISOTIN**

REF.	Contenu / Inhoud	HOLDER	€
<b>06240</b>	Ph 1 - Ph 2 - Ph 3 Pz 1 - Pz 2 - Pz 3	<b>FOX</b>	<b>22,00</b>
<b>06250</b>	2 x Pz 1 - 3 x Pz 2 1 x Pz 3	<b>FOX</b>	<b>22,00</b>
<b>06220</b>	T10 - T15 - T20 - T25 - T30 - T40	<b>FOX</b>	<b>26,00</b>

**DIATIN**



**QUICK-IN-HAND**

Boîtier ergonomique en plastique solide avec composition 1/4" pour l'atelier ou le loisir

Ergonomisch doosje uit stevige kunststof met set 1/4" voor werkplaats of vrijetijdsbesteding

04300	Contenu / Inhoud	€
	Hex bits 2.0 - 2.5 - 3.0 - 4.0 - 5.0 - 6.0 Torx bits 10 - 15 - 20 - 25 Ph bits 1 - 2 - 3 Douilles 6 pans Doppen 6 kant Adaptateur pour bits / Adapter voor bits Cliquet réversible avec poignée 2K Omschakel ratel met handgreep 2K	<b>35,00</b>



**MAGNUM BOX  
30 BITS + 1 MAGNETIC HOLDER**

REF.	Contenu / Inhoud	HOLDER	€
	<b>3 bits</b> Ph 1 - Ph 2 - Ph 3 - Pz 1 - Pz 2 - Pz 3 <b>1 bit</b> Tx 10 - Tx 15 - Tx 20 - Tx 25 - Tx 30 Tx 40 - Fl 4,5 - Fl 5,5 - Fl 6,5		
<b>06900</b>	<b>QUALITY INDUSTRY</b>	STANDA(A)RD	<b>23,50</b>
<b>06920</b>	<b>ISOTIN + BIG</b>	BIG	<b>50,00</b>
<b>06940</b>	<b>DIATIN + FOX</b>	FOX	<b>84,50</b>



**Composition bits & douilles TORX  
Bits- & dopenset TORX**

**23 pièces  
23-delig**

Cliquet réversible 5/16" / Omschakelbare ratel 5/16"  
 Bits 5/16" - 50 mm ● T20 T25 T27 T30 T40 T45 T50 T55  
 Bits 5/16" - 100 mm ● T40 T45 T55  
 Douilles 3/8" / Doppen 3/8" ● E4 E5 E6 E7 E8 E10 E12 E14 E16  
 Adaptateur/ Adapter 3/8" x 5/16"  
 Adaptateur/ Adapter 5/16" x 5/16" avec aimant/met magneet

Code	Ref.	€
1518305	<b>6400.25</b>	<b>155,00</b>

3/8"

5/16"



**Composition de bits 5/16" INBUS  
Bitsset 5/16" INBUS**

**15 pièces  
15-delig**

Bits - 50 mm ● 4 5 6 7 8 10 12 14 mm  
 Bits - 100 mm ● 5 6 7 8 10 mm  
 Adaptateur/ Adapter 3/8" x 5/16"  
 Adaptateur/ Adapter 1/2" x 5/16"

Code	Ref.	€
1518364	<b>6460.10</b>	<b>66,00</b>



**Composition de bits 5/16" TORX  
Bitsset 5/16" TORX**

**13 pièces  
13-delig**

Bits - 50 mm ● TXB20 TXB25 TXB27 TXB30 TXB40 TXB45 TXB50 TXB55  
 Bits - 100 mm ● T40 T45 T55  
 Adaptateur/ Adapter 3/8" x 5/16"  
 Adaptateur/ Adapter 1/2" x 5/16"

Code	Ref.	€
1518372	<b>6460.20</b>	<b>66,00</b>







**Jeu de douilles IMPACT, bits & accessoires  
Set Impactdoppen, bits en toebehoren**

Composition universelle pour visseuse ou usage manuel  
 Universele set voor machine of manueel gebruik  
 Douilles 6 pans / 6-kant doppen: 5 6 7 8 9 10 11 12 13 14  
 Bits ⊕ 2x Ph1 Ph2 Ph3  
 Bits ⊕ 2x Pz1 Pz2 Pz3  
 Bits ● 1x 2 2.5 3 4 5 6 mm  
 Bits ⊖ 1x 4.0 4.5 5.0 5.5 6.0 6.5  
 Adaptateur 50 mm pour douilles / Adapter 50 mm voor dop  
 Adaptateur 25 mm pour bit / Adapter 25 mm voor bit  
 Porte bit / Bithouder FOX II  
 Poignée porte-bit à cliquet / Bitschroevendraaier met ratel  
 Cliquet réversible / Omkeerbare ratel

Code	Ref.	€
0100804320	<b>04320</b>	<b>70,00</b>



**Composition mixte pour l'atelier ou le chantier  
Gemengde samenstelling voor de werkplaats of werf**

Contenu / Inhoud:

- Mèches à bois / Houtboren 4.0 - 5.0 - 6.0 - 8.0
- Mèches à métaux / Metaalboren 4.0 - 5.0 - 6.0 - 8.0
- Mèches à béton / Betonboren 4.0 - 5.0 - 6.0 - 8.0
- Bits ⊕ 2x Ph1 - Ph2 - Ph3
- Bits ⊕ 2x Pz1 - Pz2 - Pz3
- Bits ⊕ 1x T10 - T15 - T20 - T25 - T30 - T40
- Bits ● 1X HEX 2.0 - 2.5 - 3.0 - 4.0 - 5.0 - 6.0
- Bits ⊖ 1X SW 4.5 - 5.5 - 6.5
- Douilles magnétiques / Magnetische bitdoppen : 7.0 - 8.0 - 10.0 mm
- Fraise à bois / Houffrees
- Porte-embout magnétique / Magnetische bithouder

Code	Ref.	€
010884930	<b>04930</b>	<b>55,00</b>



**Douilles magnétiques - 50 mm  
Magnetische bitdoppen - 50 mm**

**POWER IMPACT  
POWER IMPACT**

Code	Ref.	Ø mm	€
010832472	<b>10.663</b>	5.0	<b>5,00</b>
010832480	<b>10.664</b>	5.5	<b>5,00</b>
010832499	<b>10.665</b>	6.0	<b>5,00</b>
010832502	<b>10.666</b>	1/4"	<b>5,00</b>
010832510	<b>10.667</b>	7.0	<b>5,00</b>
010832529	<b>10.668</b>	8.0	<b>5,00</b>
010832537	<b>10.670</b>	5/16"	<b>5,00</b>
010832545	<b>10.671</b>	10.0	<b>5,00</b>
010832553	<b>10.672</b>	11.0	<b>5,50</b>
010832561	<b>10.673</b>	12.0	<b>5,50</b>
010832588	<b>10.674</b>	13.0	<b>5,50</b>
010832596	<b>10.676</b>	3/8"	<b>5,50</b>

**Jeu de douilles magnétiques  
Set magnetische doppen**

**7 pièces  
7 delig**

Code	Ref.	€
010832600	<b>7ALL/5000</b>	<b>29,00</b>
Ø mm 1/4" 3/8" 7 8 10 12 13 mm		

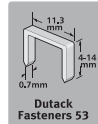

**Machine compacte pour petits travaux de décoration**

- Boîtier en plastique, mécanisme en acier
- Poids 320 g

**Compacte, lichte handtacker voor kleine decoratiewerken**

- Kunststof behuizing, met werkend gedeelte in staal
- Gewicht 320 g

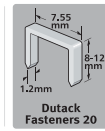
Ref.	V.E.	€	EAN
<b>618</b>	1	<b>9,90</b>	8712008074847



**Machine pour utilisation avec agrafes larges, et agrafes de câble jusqu'à Ø 6 mm (max 50V)**

- Boîtier en aluminium, avec renforts en plastique souple
- Puissance de frappe réglable
- Poids 654 g

**Machine voor gebruik met brede nieten, en kabelnieten voor kabel tot Ø 6 mm (max 50V)**

- Aluminium behuizing bekleed met soepele kunststof
- Instelbare slagkracht regeling
- Gewicht 654 g

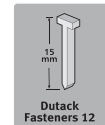
Ref.	V.E.	€	EAN
<b>806</b>	1	<b>28,50</b>	8712008065982

**Machine polyvalente pour utilisation avec agrafes standards, agrafes larges, ou clous 15 mm**

- Boîtier en aluminium, avec renforts en plastique souple
- Puissance de frappe réglable
- Poids 707 g

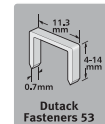
**Polyvalente machine voor gebruik met standaard nieten, brede nieten, of spijkers 15 mm**

- Aluminium behuizing bekleed met soepele kunststof
- Instelbare slagkracht regeling
- Gewicht 707 g

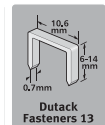

Ref.	V.E.	€	EAN
<b>815</b>	1	<b>31,50</b>	8712008065999

**Machine professionnelle pour l'agrafage de câble électrique, rond ou plat, jusque Ø 12.5 mm (max 500V)**

- Boîtier en aluminium, mécanisme en acier
- Puissance de frappe réglable
- Poids 1155 g

**Professionele machine voor het nieten van platte of ronde elektrische kabel**

- Aluminium behuizing, binnenwerk in staal
- Instelbare slagkracht regeling
- Gewicht 1155 g

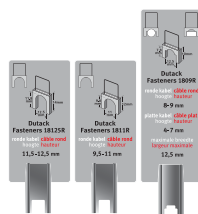

Ref.	V.E.	€	EAN
<b>669</b>	1	<b>42,50</b>	8712008065975

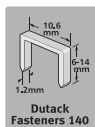

**Machine professionnelle pour l'agrafage rapide sur toiture, ou dans les zones d'emballage**

- Boîtier et mécanisme en métal. Poignée ergonomique
- Agrafes 6-14 mm
- Poids 915 g

**Professionele machine voor snel nieten bv. Bij dakwerken of verpakingswerkzaamheden.**

- Behuizing en binnenwerk in metaal. Ergonomische greep
- Nieten 6-14 mm
- Gewicht 915 g

Ref.	V.E.	€	EAN
<b>585</b>	1	<b>30,00</b>	8712008066002

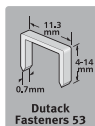

**Machine compacte pour l'agrafage rapide sur toiture, ou dans les zones d'emballage**

- Boîtier et mécanisme en métal. Poignée ergonomique
- Agrafes 6-10 mm
- Poids 440 g

**Compacte machine voor snel nieten bv. Bij dakwerken of verpakingswerkzaamheden.**

- Behuizing en binnenwerk in metaal. Ergonomische greep
- Nieten 6-10 mm
- Gewicht 440 g

Ref.	V.E.	€	EAN
<b>530</b>	1	<b>23,00</b>	8712008074854

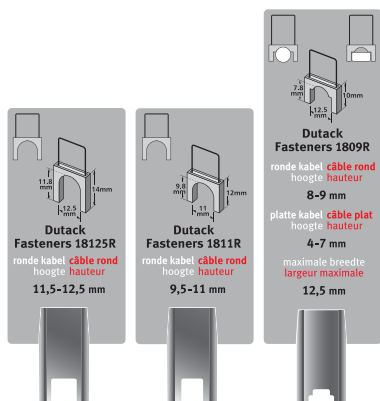
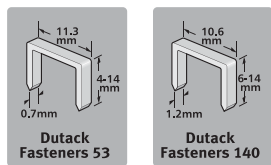
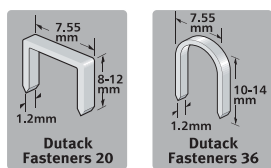
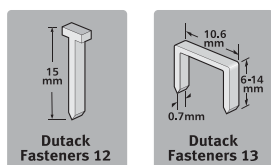

Ref	longueur lengte	pcs stuk	V.E.	EAN 8712008	€
<b>Spijker / Clou type 12</b>					
<b>5138049</b>	15 mm	1000	6	066620	<b>3,50</b>
<b>Niet / Agrafe type 13</b>					
<b>5011001</b>	6 mm	1000	6	066637	<b>1,95</b>
<b>5011002</b>	8 mm	1000	6	066644	<b>2,05</b>
<b>5011003</b>	10 mm	1000	6	066651	<b>2,25</b>
<b>Niet / Agrafe type 20</b>					
<b>5011007</b>	8 mm	1000	6	066705	<b>3,25</b>
<b>5011008</b>	10 mm	1000	6	066712	<b>3,45</b>
<b>Niet / Agrafe type 36</b>					
<b>5011010</b>	12 mm	1000	6	066736	<b>3,75</b>
<b>5011011</b>	14 mm	1000	6	066743	<b>4,10</b>
<b>Niet / Agrafe type 53</b>					
<b>5011012</b>	6 mm	1000	6	066750	<b>1,95</b>
<b>5011013</b>	8 mm	1000	6	066767	<b>2,05</b>
<b>5011014</b>	10 mm	1000	6	066774	<b>2,25</b>
<b>5011015</b>	12 mm	1000	6	066781	<b>2,45</b>
<b>5011016</b>	14 mm	1000	6	066798	<b>2,65</b>
<b>Niet / Agrafe type 140</b>					
<b>5011017</b>	6 mm	1000	6	066804	<b>2,65</b>
<b>5011018</b>	8 mm	1000	6	066811	<b>2,90</b>
<b>5011019</b>	10 mm	1000	6	066828	<b>3,25</b>
<b>5011020</b>	12 mm	1000	6	066835	<b>3,45</b>
<b>5011021</b>	14 mm	1000	6	066842	<b>3,75</b>
<b>Kabelniet / Agrafe de câble</b>					
<b>5011004</b>	1809-10 mm	200	6	066675	<b>9,60</b>
<b>5011005</b>	1811-12 mm	200	6	066682	<b>10,00</b>
<b>5011006</b>	1825-14 mm	200	6	066699	<b>10,25</b>

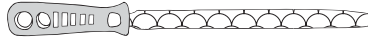
**Limes plates à taille double - poignée PVC**  
**Blokvijl dubbele kap met PVC-heft**

REF.	Type	€
<b>2501P 6B</b>	6" bâtarde / bastaard	<b>5,20</b>
<b>2501P 8B</b>	8" bâtarde / bastaard	<b>6,10</b>
<b>2501P 10B</b>	10" bâtarde / bastaard	<b>7,30</b>
<b>2501P 12B</b>	12" bâtarde / bastaard	<b>9,70</b>
<hr/>		
<b>2501P 6MD</b>	6" 1/2 douce / half zoet	<b>5,40</b>
<b>2501P 8MD</b>	8" 1/2 douce / half zoet	<b>6,40</b>
<b>2501P 10MD</b>	10" 1/2 douce / half zoet	<b>7,70</b>
<b>2501P 12MD</b>	12" 1/2 douce / half zoet	<b>10,10</b>

**Limes triangulaires à manche PVC**  
**Driekante vijl met PVC-heft**

REF.	Type	€
<b>2504P 6B</b>	6" bâtarde / bastaard	<b>5,70</b>
<b>2504P 8B</b>	8" bâtarde / bastaard	<b>6,50</b>
<b>2504P 10B</b>	10" bâtarde / bastaard	<b>8,80</b>
<hr/>		
<b>2504P 6MD</b>	6" 1/2 douce / half zoet	<b>5,90</b>
<b>2504P 8MD</b>	8" 1/2 douce / half zoet	<b>6,70</b>
<b>2504P 10MD</b>	10" 1/2 douce / half zoet	<b>9,00</b>

**Limes demi-rondes à poignée PVC**  
**Halfronde vijl met PVC-heft**

REF.	Type	€
<b>2502P 6B</b>	6" bâtarde / bastaard	<b>6,30</b>
<b>2502P 8B</b>	8" bâtarde / bastaard	<b>6,90</b>
<b>2502P 10B</b>	10" bâtarde / bastaard	<b>9,30</b>
<b>2502P 12B</b>	12" bâtarde / bastaard	<b>11,90</b>
<hr/>		
<b>2502P 6MD</b>	6" 1/2 douce / half zoet	<b>6,70</b>
<b>2502P 8MD</b>	8" 1/2 douce / half zoet	<b>7,30</b>
<b>2502P 10MD</b>	10" 1/2 douce / half zoet	<b>9,60</b>
<b>2502P 12MD</b>	12" 1/2 douce / half zoet	<b>12,20</b>

**Limes carrées à manche PVC**  
**Vierkante vijl met PVC-heft**

REF.	Type	€
<b>2505P 6B</b>	6" bâtarde / bastaard	<b>5,60</b>
<b>2505P 8B</b>	8" bâtarde / bastaard	<b>6,00</b>
<b>2505P 10B</b>	10" bâtarde / bastaard	<b>7,10</b>
<hr/>		
<b>2505P 6MD</b>	6" 1/2 douce / half zoet	<b>5,80</b>
<b>2505P 8MD</b>	8" 1/2 douce / half zoet	<b>6,20</b>
<b>2505P 10MD</b>	10" 1/2 douce / half zoet	<b>7,30</b>

**Limes rondes à poignée PVC**  
**Ronde vijl met PVC-heft**

REF.	Type	€
<b>2503P 6B</b>	6" bâtarde / bastaard	<b>5,10</b>
<b>2503P 8B</b>	8" bâtarde / bastaard	<b>5,40</b>
<b>2503P 10B</b>	10" bâtarde / bastaard	<b>6,80</b>
<b>2503P 12B</b>	12" bâtarde / bastaard	<b>8,60</b>
<hr/>		
<b>2503P 6MD</b>	6" 1/2 douce / half zoet	<b>5,20</b>
<b>2503P 8MD</b>	8" 1/2 douce / half zoet	<b>5,20</b>
<b>2503P 10MD</b>	10" 1/2 douce / half zoet	<b>7,00</b>
<b>2503P 12MD</b>	12" 1/2 douce / half zoet	<b>9,00</b>

**Limes triangulaires à angles vifs pour scies**  
**Scherp driekantig voor zagen**

REF.	Type	€
<b>2530P 5</b>	5" standa(a)rd	<b>5,10</b>
<b>2530P 6</b>	6" standa(a)rd	<b>5,20</b>
<hr/>		
<b>2531P 5</b>	5" effilé / dun	<b>5,10</b>
<b>2531P 6</b>	6" effilé / dun	<b>5,20</b>
<hr/>		
<b>2532P 5</b>	5" très effilé / zeer dun	<b>5,10</b>
<b>2532P 6</b>	6" très effilé / zeer dun	<b>5,20</b>

**Limes rondes pour scies à chaîne**  
**Ronde kettingvijl**

REF.	Type	€
<b>2551 - 5/32"</b>	Ø 5/32" sans manche zonder hecht	<b>1,70</b>
<b>2551 - 3/16"</b>	Ø 3/16" sans manche zonder hecht	<b>1,70</b>
<b>2551 - 7/32"</b>	Ø 7/32" sans manche zonder hecht	<b>1,70</b>
<b>2551P - 3/16"</b>	Ø 3/16" avec manche PVC met PVC-hecht	<b>3,80</b>

**Jeu de 4 limes d'atelier en pochette**  
**Set van 4 vijlen in zakje**

REF.	Contenu / Inhoud	€
<b>2500P</b>	Plate 8" / Demi-ronde 8" Ronde 8" / Râpe demi-ronde 8" Blok vijl 8" / Halfronde 8" Ronde 8" / Halfronde rasp 8"	<b>25,50</b>

**Râpes à bois demi-rondes**  
**Halfronde rasp**

REF.	Type	€
<b>2522P 8B</b>	8" bâtarde / bastaard	<b>8,00</b>
<b>2522P 10B</b>	10" bâtarde / bastaard	<b>10,10</b>
<b>2522P 8MD</b>	8" 1/2 douce / half zoet	<b>8,20</b>
<b>2522P 10MD</b>	10" 1/2 douce / half zoet	<b>10,30</b>

**Limes Aiguilles 160 mm à manche rond en pochette**  
**Naaldvijlen 160 mm met ronde heft in zakje**



REF.	Contenu / Inhoud	€
<b>2570</b>	Etui de 6 limes E1 à E6 Vijlenset 6-dlg E1 tot E6	<b>17,20</b>

**Râpes à bois rondes**  
**Ronde rasp**

REF.	Type	€
<b>2521P 8MD</b>	8" 1/2 douce / half zoet	<b>7,30</b>
<b>2521P 10MD</b>	10" 1/2 douce / half zoet	<b>9,30</b>

**Jeu de 6 limes à clés en pochette**  
**Sleutelvijlenset 6-delig in zakje**

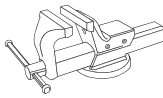
REF.	Type	€
<b>2555</b>		<b>17,30</b>



## ETAUX PARALLÈLES - PARALLELE BANKSCHROEVEN

**Corps forgé en acier spécial C43**  
**Mors et enclume trempés par induction**  
**Système de réglage breveté**  
**Label de garantie contre tout vice éventuel de fabrication**

**Gesmeed speciaalstaal C43**  
**Bekken en aambeeld gehard**  
**Optimale krachtoverbrenging**  
**Garantie label tegen elke vorm van eventuele namaak**

### PANTHER

Enclume trempée en surface et polie  
 Mors à tube fixes, forgés et trempés par induction  
 Aambeeld met gehard en gepolijst oppervlakte  
 Vaste pijpklemmen, gesmeed en gehard door inductie

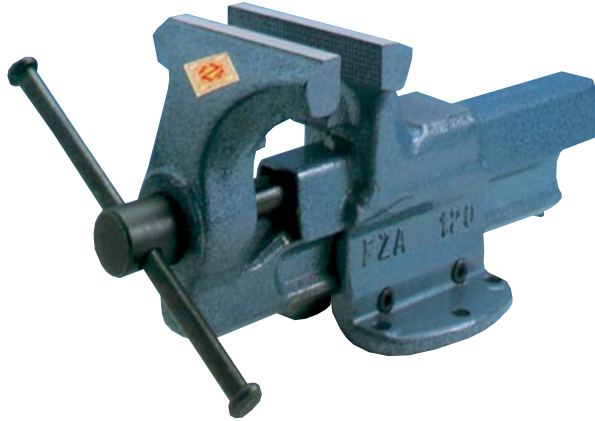

### MONDIAL

A large enclume trempée en surface et polie  
 Dispositif de montage pour mors à tube  
 Groot gehard en gepolijst aambeeld  
 Montagepunt voor pijpklemmen

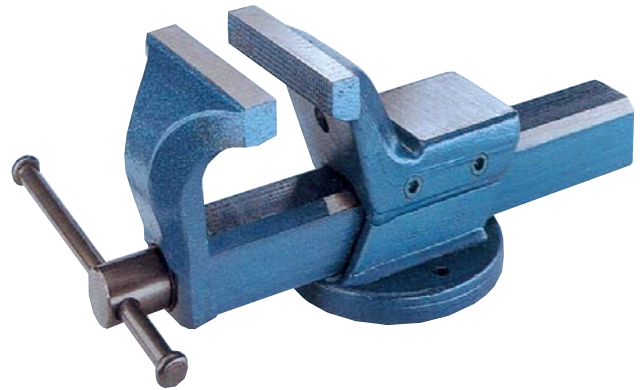

Type	Larg. Mors Bekbr.	Ouv. Spanw.	Ouv. mors à tube Spanw. pijpklem	kg	€
<b>P/100</b>	100 mm	100 mm	14-38 mm	5,5	<b>144,00</b>
<b>P/120</b>	120 mm	120 mm	15-46 mm	10	<b>176,00</b>
<b>P/140</b>	140 mm	180 mm	20-100 mm	19	<b>250,00</b>
<b>P/160</b>	160 mm	210 mm	22-100 mm	28	<b>353,00</b>

Type	Larg. Mors Bekbr.	Ouv. Spanw.	Ouv. mors à tube Spanw. pijpklem	kg	€
<b>M/100</b>	100 mm	125 mm	15-75 mm	7,0	<b>134,00</b>
<b>M/125</b>	125 mm	150 mm	15-100 mm	11	<b>158,00</b>
<b>M/150</b>	150 mm	200 mm	15-125 mm	17	<b>221,00</b>
<b>M/175</b>	175 mm	220 mm	15-150 mm	26	<b>285,00</b>

### TENAX

Large enclume trempée en surface et peinte  
 Dispositif demontage pour mors à tube  
 Base carrée en tôle d'acier  
 Groot gehard aambeeld met gelakte oppervlakte  
 Montagepunt voor pijpklemmen  
 Vierkante basis in plaatstaal

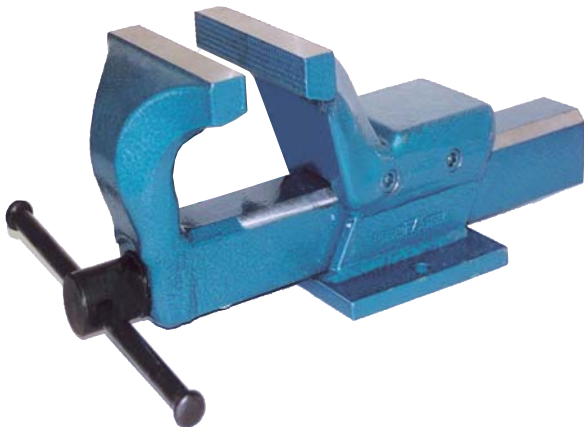

### EUROSTAHL

Etau en acier à machoires soudées et large enclume  
 Base carrée en tôle d'acier  
 Stalen bankschroef, vaste bekken, groot aambeeld  
 Vierkante basis in plaatstaal

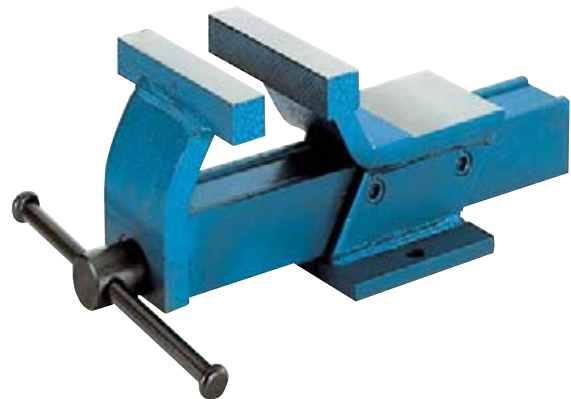

Type	Larg. Mors Bekbr.	Ouv. Spanw.	Ouv. mors à tube Spanw. pijpklem	kg	€
<b>TE/125</b>	125 mm	150 mm	15-100 mm	10	<b>137,00</b>
<b>TE/150</b>	150 mm	200 mm	15-125 mm	17	<b>194,00</b>

Type	Larg. Mors Bekbr.	Ouv. Spanw.	kg	€
<b>ES/ 80</b>	80 mm	100 mm	3,7	<b>72,00</b>
<b>ES/110</b>	110 mm	120 mm	6,7	<b>87,00</b>
<b>ES/130</b>	130 mm	140 mm	11,3	<b>111,00</b>
<b>ES/150</b>	150 mm	155 mm	15,9	<b>128,00</b>

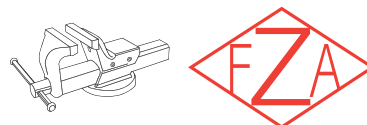

**JEU DE MORS À TUBE - Trempé par induction**  
**SET PIJPKLEMMEN - Bekken gehard door inductie**

REF.	Pour/Voor type	Gr	€
<b>D41-100</b>	M 100	321	<b>22,00</b>
<b>D41-125</b>	M 125/TE125	405	<b>22,00</b>
<b>D41-150</b>	M 150/TE150	830	<b>23,00</b>
<b>D41-175</b>	M 175	1040	<b>24,50</b>

**DISPOSITIF DE REGLAGE EN HAUTEUR / DRAAILIFT**

Pour les modèles MONDIAL / PANTHER  
 (préciser le type d'étau à la commande)  
 Voor modellen MONDIAL / PANTHER  
 (type vermelden bij bestelling)

REF.	Pour/Voor type	Kg	€
<b>SOLL 125</b>	M125 / P125	9	<b>249,00</b>
<b>SOLL 150</b>	M150 / P140	9	<b>249,00</b>
<b>SOLL 175</b>	M175 / P160	9	<b>249,00</b>

**BASES TOURNANTES**  
**DRAAIPLAAT**

REF.	Pour/Voor type	Kg	€
<b>D38-100</b>	M100	1,4	<b>40,00</b>
<b>D38-125</b>	M125	2,0	<b>48,00</b>
<b>D38-150</b>	M150	2,8	<b>63,00</b>
<b>D38-175</b>	M175	4,0	<b>79,00</b>
<b>BG-125</b>	TE125	2,0	<b>51,00</b>
<b>BG-150</b>	TE150	2,8	<b>59,00</b>
<b>BG-100</b>	P100	1,5	<b>39,00</b>
<b>BG-120</b>	P120	2,0	<b>48,00</b>
<b>BG-140</b>	P140	3,0	<b>67,00</b>
<b>BG-160</b>	P160	4,0	<b>78,00</b>

**ACCESSOIRES MAGNÉTIQUES EN ALU**  
**MAGNETISCHE BESCHERMBEKKEN UIT ALU**

Type	mm	€	Type	mm	€
		paire/paar			paire/paar
GAN 100 N	100	<b>25,30</b>	GAN 150 G	150	<b>34,70</b>
GAN 120 N	120	<b>27,70</b>	GAN 160 G	160	<b>37,00</b>
GAN 125 N	125	<b>27,70</b>	GAN 175 G	175	<b>37,00</b>
GAN 140 N	140	<b>28,50</b>	GAN 100 F	100	<b>28,70</b>
GAN 150 N	150	<b>28,50</b>	GAN 120 F	120	<b>32,00</b>
GAN 160 N	160	<b>31,40</b>	GAN 125 F	125	<b>32,00</b>
GAN 175 N	175	<b>31,40</b>	GAN 140 F	140	<b>34,70</b>
GAN 100 P	100	<b>28,70</b>	GAN 150 F	150	<b>34,70</b>
GAN 120 P	120	<b>32,00</b>	GAN 160 F	160	<b>37,00</b>
GAN 125 P	125	<b>32,00</b>	GAN 175 F	175	<b>37,00</b>
GAN 140 P	140	<b>34,70</b>	GAN 100 FE	100	<b>33,40</b>
GAN 150 P	150	<b>34,70</b>	GAN 120 FE	120	<b>35,60</b>
GAN 160 P	160	<b>37,00</b>	GAN 125 FE	125	<b>35,60</b>
GAN 175 P	175	<b>37,00</b>	GAN 140 FE	140	<b>39,00</b>
GAN 100 G	100	<b>28,70</b>	GAN 150 FE	150	<b>39,00</b>
GAN 120 G	120	<b>32,00</b>	GAN 160 FE	160	<b>41,30</b>
GAN 125 G	125	<b>32,00</b>	GAN 175 FE	175	<b>41,30</b>
GAN 140 G	140	<b>34,70</b>			

**Type N** Mors à 6 rainures / Bekken met 6 ribben  
**Type P** Mors prismatiques / Bekken met prisma  
**Type G** Mors recouverts de caoutchouc  
 Bekken bekleed met rubber  
**Type F** Mors recouverts de fibres synthétiques contre les marques  
 Bekken met speciaal fiber tegen krassen  
**Type FE** Mors recouverts de feutre ressort  
 Bekken met verend vilt

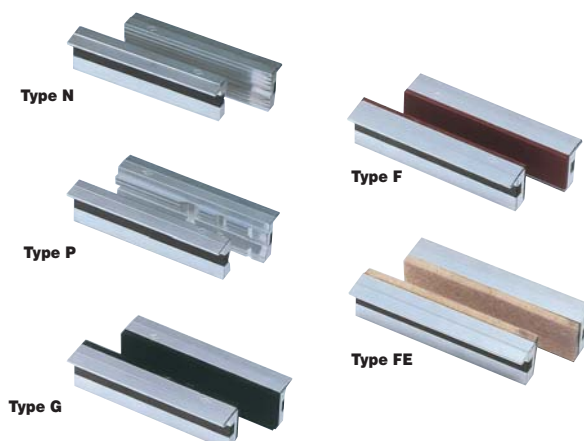

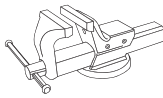

## ETAUX PARALLÈLES - PARALLELE BANKSCHROEVEN

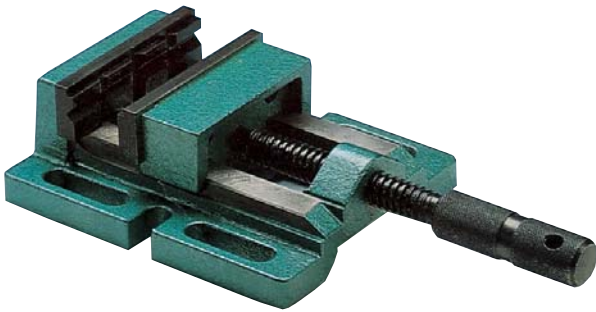

MT/3

A machoires prismatiques trempées et rectifiées  
Corps en fonte

*Bekken met prisma, gehard en geslepen  
Lichaam in gietijzer*

Type	Larg. Mors Bekbr.	Ouv. Spanw.	kg	€
<b>E/60080</b>	80 mm	62 mm	4.0	<b>60,00</b>
<b>E/60100</b>	100 mm	60 mm	5.0	<b>70,00</b>
<b>E/60120</b>	120 mm	100 mm	7.5	<b>103,00</b>
<b>E/60150</b>	150 mm	140 mm	15.0	<b>165,00</b>



MT/5

A machoires prismatiques trempées et rectifiées  
Corps en fonte avec bloc de protection de la vis

*Bekken met prisma, gehard en geslepen  
Lichaam in gietijzer met bescherming van de vijs*

Type	Larg. Mors Bekbr.	Ouv. Spanw.	kg	€
<b>E/40080</b>	80 mm	80 mm	4	<b>100,00</b>
<b>E/40100</b>	100 mm	110 mm	9	<b>142,00</b>
<b>E/40120</b>	120 mm	150 mm	16	<b>214,00</b>
<b>E/40150</b>	150 mm	180 mm	24	<b>285,00</b>



MTP/3

A machoires réversibles (face lisse prismatiques ou rainurée) trempées et rectifiées  
Possibilité de fixation latérale ou frontale  
Grande capacité de serrage - Corps en fonte

*Omkeerbaar bekken (vlakke bovenkant met prisma of met groefjes)  
Mogelijkheid tot vastklemming aan de voorkant of zijdelings  
Grote klemcapaciteit - Lichaam in gietijzer*

Type	Larg. Mors Bekbr.	Ouv. Spanw.	kg	€
<b>E/70110</b>	110 mm	130 mm	9.5	<b>293,00</b>
<b>E/70135</b>	135 mm	160 mm	14.0	<b>384,00</b>
<b>E/70160</b>	160 mm	220 mm	25.5	<b>598,00</b>

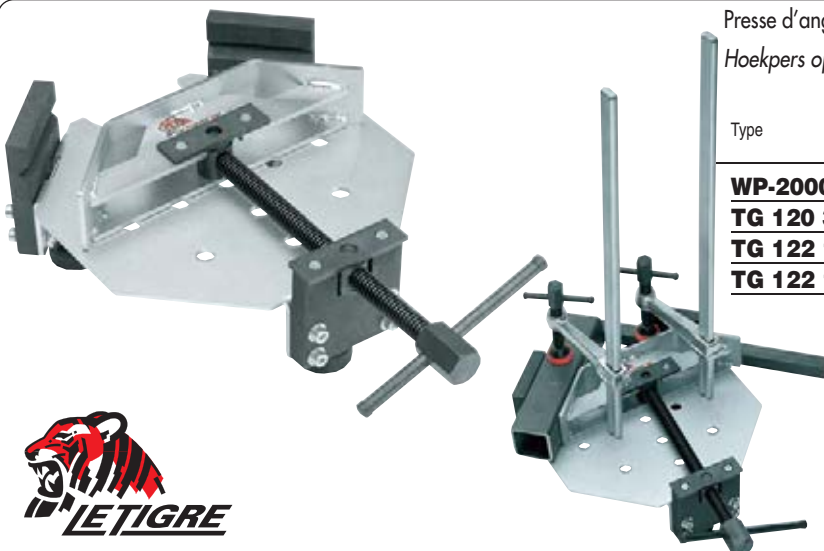

Presse d'angle sur établi, pour montage et soudure

*Hoekpers op werkband, om te monteren en te solderen*

Type	Largeur de passage max. Max grootte voor doorgang	€
<b>WP-2000</b>	120 mm - 12,30 kg	<b>157,00</b>
<b>TG 120 30</b>	tige 30 cm / rail 30 cm	<b>10,90</b>
<b>TG 122 12</b>	bras coulissant 120 mm / schuifarm 120 mm	<b>38,00</b>
<b>TG 122 14</b>	bras coulissant 140 mm / schuifarm 140 mm	<b>38,00</b>



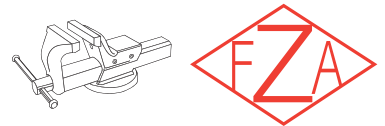

**ETAUX A TUBES**

Corps en acier forgé  
Machoières en acier trempé.  
Partie supérieure rabattable  
pour une insertion  
rapide du tuyau  
à travailler  
Système breveté

**BUIZENBANKSCHROEF**

Lichaam in gesmeed staal  
Bekken in gehard staal  
Bovenste gedeelte  
inklapbaar voor het  
gemakkelijk verwerken  
van buizen  
Gebreveteerd systeem



Type	Tubes Buizen	kg	€
<b>1000-2</b>	2"	8	<b>128,00</b>
<b>1000-3</b>	3"	12	<b>185,00</b>

**ETABLI D'INSTALLATEUR**

Muni d'un système à 5 trous de diam. différents pour ployer les tubes jusqu'à 1 1/2", d'un plateau porte-outils et d'un étau en acier forgé à système d'ouverture breveté

**INSTALLATIEWERKTAFEL**

Voorzien van een systeem met 5 gaten van verschillende diameters voor het buigen van buizen tot 1 1/2" met gereedschapshouder en met bankschroef van gesmeed staal met gebreveteerd openingssysteem



Type	Tubes Buizen	kg	€
<b>1100-02</b>	2"	20	<b>205,00</b>
<b>1100-03</b>	3"	32	<b>270,00</b>



**ÉTABLI D'ATELIER PLIANT**

Plateau en hêtre stratifié de 30 mm,  
protégé par un encadrement en acier  
Châssis en tube d'acier

**WERKBANK OPKLAPBAAR**

30 mm-beukenblad, beschermd door stalen kader  
Onderstel van stalen buis

Type	kg	€
<b>TAV 1000</b>	1000 x 700 mm	35 <b>260,00</b>

**ENCLUMES**

En acier à 2 bigornes

**AAMBEELDEN**

In staal met 2 hoornen



Type	kg	Larg. table Grootte tafel	Long. table Lengte tafel	€
<b>R112</b>	20	98 mm	450 mm	<b>300,00</b>
<b>R113</b>	30	115 mm	520 mm	<b>420,00</b>
<b>R115</b>	50	140 mm	590 mm	<b>630,00</b>
<b>R117</b>	70	160 mm	680 mm	<b>900,00</b>
<b>R119</b>	100	170 mm	755 mm	<b>1 280,00</b>

**ENCLUMES**

En fonte à 2 bigornes

**AAMBEELDEN**

In gietijzer met 2 hoornen



Type	kg	Larg. table Grootte tafel	Long. table Lengte tafel	€
<b>T101</b>	2,5	53 mm	192 mm	<b>18,00</b>
<b>T102</b>	5,0	65 mm	250 mm	<b>35,00</b>
<b>T103</b>	10,0	89 mm	330 mm	<b>67,00</b>

**TYPE**      **V.E.**      **€**      EAN  
4016671...



**252/15** 950 g 1 **60,20** 009743



**252/40 1/2** 1050 g 1 **65,80** 010206

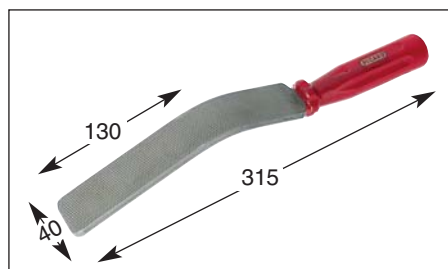

**251/8 1/2** 500 g 1 **72,30** 009651

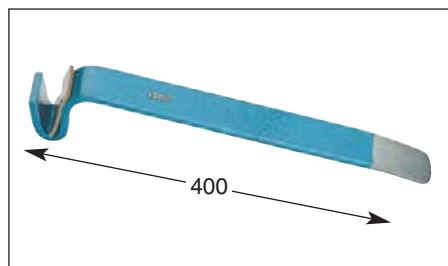

**251/8** 1000 g 1 **30,10** 009644

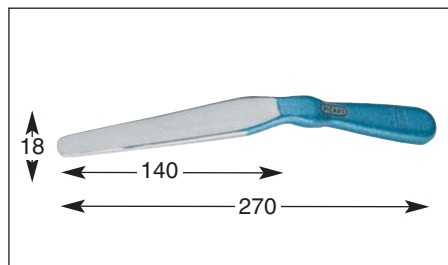

**252/18** 550 g 1 **35,20** 009781

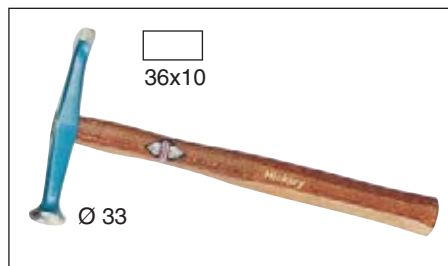

**251/4** 500 g 1 **33,50** 009569

**TYPE**      **V.E.**      **€**      EAN  
4016671...



**252/16** 900 g 1 **39,00** 009750

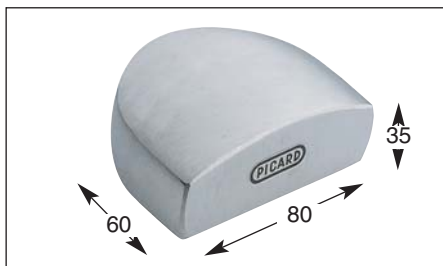

**252/12** 1050 g 1 **42,70** 009712



**252/65** 400 mm 1 **35,20** 010558

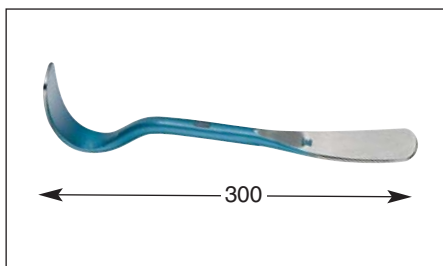

**252/19** 2200 g 1 **90,80** 009804

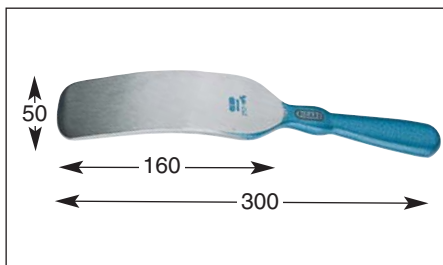

**252/18 1/2** 850 g 1 **45,20** 009798

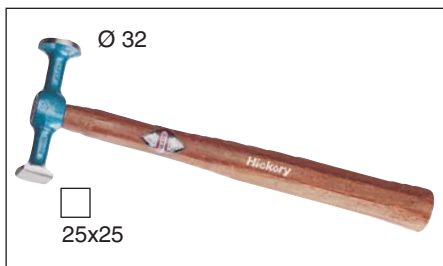

**252/22** 300 g 1 **33,00** 009842

**TYPE**      **V.E.**      **€**      EAN  
4016671...



**252/16 1/2** 1330 g 1 **71,80** 009767

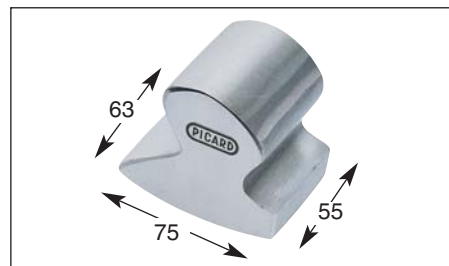

**252/13** 1200 g 1 **63,00** 009729

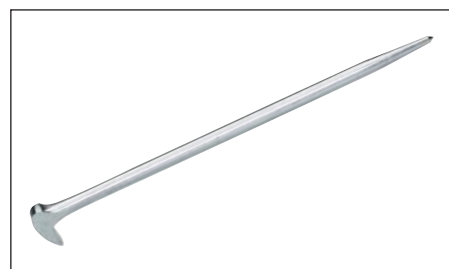

**252/31** 400 mm 1 **35,30** 010107

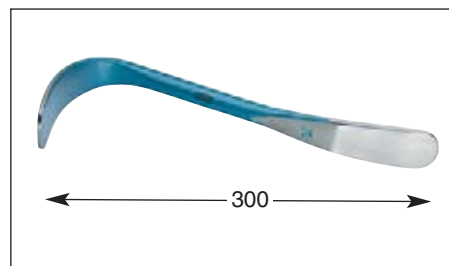

**252/42** 1900 g 1 **74,20** 010237

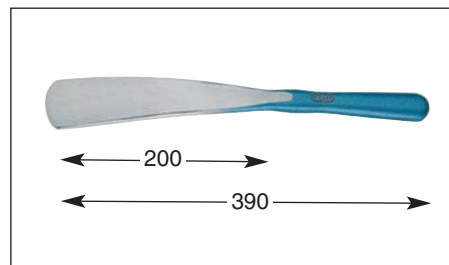

**252/19 1/2** 950 g 1 **55,70** 009811

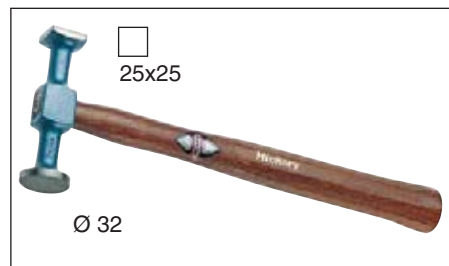

**252/22K** 300 g 1 **42,20** 009866

TYPE V.E. € EAN  
4016671...

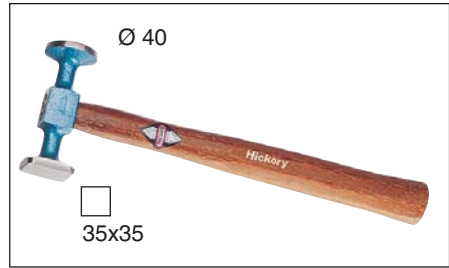

**252/23** 380 g 1 **37,90** 009880

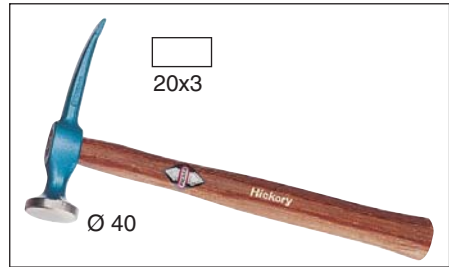

**252/26** 450 g 1 **43,50** 009965

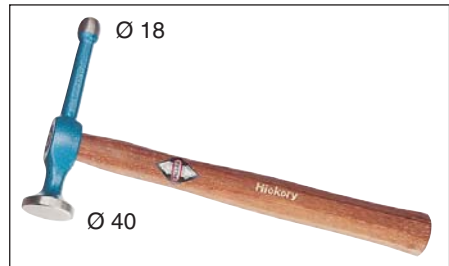

**252/28** 460 g 1 **38,50** 010022

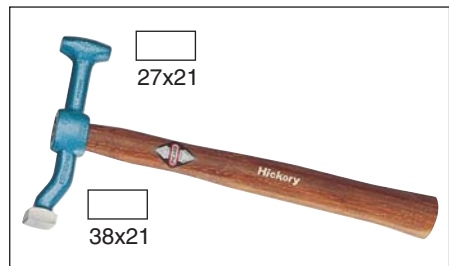

**252/46** 450 g 1 **46,10** 010282

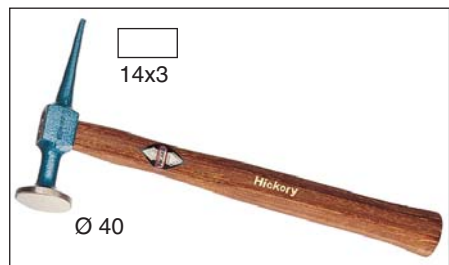

**252/52** 330 g 1 **44,10** 010411



**16501** 300 g 6 **31,30** 006797

TYPE V.E. € EAN  
4016671...

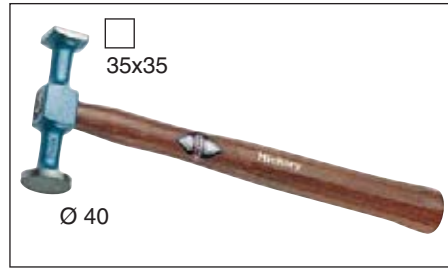

**252/23K** 380 g 1 **45,50** 009903

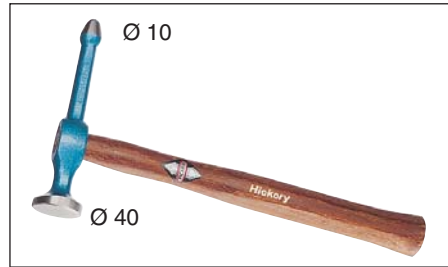

**252/27** 410 g 1 **38,30** 009989

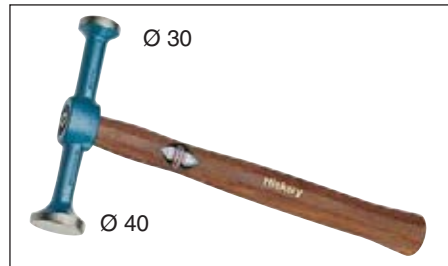

**252/29** 430 g 1 **38,60** 010060

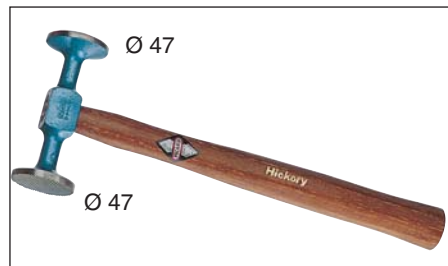

**252/53** 500 g 1 **55,20** 009880

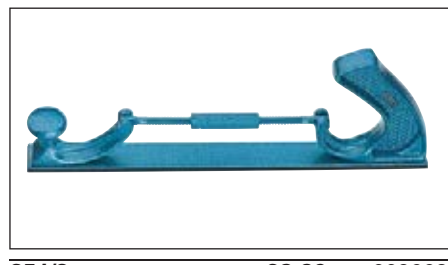

**251/9 1/2** avec lime/met vijl **68,30** 009668

**251/9 a** lime/vijl **33,00** 009675



**16901-375** 6 **31,30** 006896

**16901-500** 6 **31,30** 006902

TYPE V.E. € EAN  
4016671...

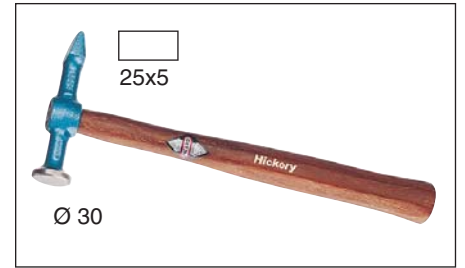

**252/25** 300 g 1 **33,00** 009927



**252/27 1/2** 310 g 1 **39,60** 010008

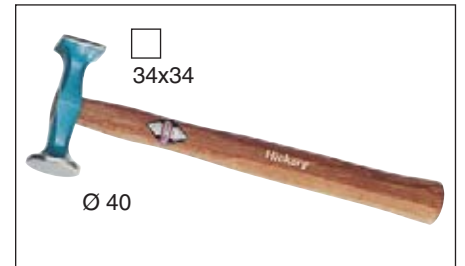

**252/30** 430 g 1 **36,00** 010084

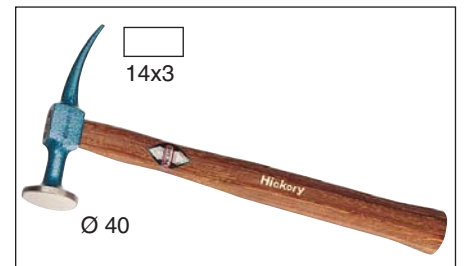

**252/51** 330 g 1 **43,30** 010381



**99062-300** 1 **5,90** 018868

**99062-320** 1 **6,40** 018875



**17401-500** 6 **31,30** 007053



**Règles en acier inoxydable**
**CE-Classe II - type flexible**

- Acier ressort à section étroite
- Surface mate non réfléchissante
- Graduation gravée à l'acide

**Buigzame meetlatten uit inoxstaal**
**EC-Klasse II**

- Veerstaal met smalle sectie
- Mat en anti-reflecterend meetvlak
- Schaalverdeling d.m.v. zuur gegraveerd

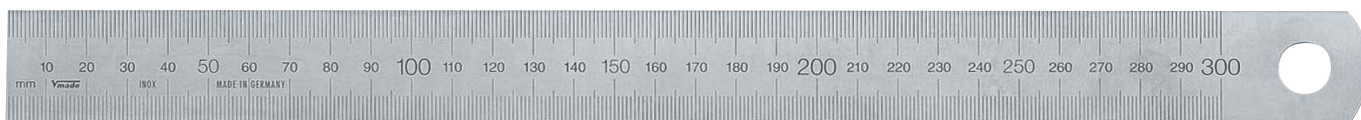
Type A mm mm	Type B ½ mm mm	Type C Inch mm	Longueur Lengte mm	Section Sectie mm	V.E.	€
<b>10010015</b>	<b>10020015</b>	<b>10030015</b>	150	13x0.5	10	<b>2,05</b>
<b>10010020</b>	<b>10020020</b>	-	200	13x0.5	10	<b>2,15</b>
<b>10010025</b>	<b>10020025</b>	-	250	13x0.5	10	<b>2,20</b>
<b>10010030</b>	<b>10020030</b>	<b>10030030</b>	300	13x0.5	10	<b>2,30</b>
<b>12010050</b>	<b>12020050</b>	-	500	18x0.5	5	<b>4,60</b>
<b>12010100</b>	<b>12020100</b>	-	1000	18x0.5	5	<b>12,00</b>

**Règles en acier inoxydable**
**CE-Classe II - type rigide**

- Acier ressort inoxydable à section large
- Surface mate non réfléchissante
- Graduation gravée à l'acide

**Stevige meetlatten uit inoxstaal**
**EC-Klas II**

- Veerstaal met brede sectie
- Mat en anti-reflecterend meetvlak
- Schaalverdeling d.m.v. zuur gegraveerd

Type A mm mm	Type B ½ mm mm	Type D Inch mm	Longueur Lengte mm	Section Sectie mm	V.E.	€
<b>18010030</b>	<b>18020030</b>	<b>18040030</b>	300	30x1.0	10	<b>5,50</b>
<b>18010050</b>	<b>18020050</b>	<b>18040050</b>	500	30x1.0	10	<b>11,20</b>
<b>18010100</b>	<b>18020100</b>	<b>18040100</b>	1000	30x1.0	1	<b>22,00</b>
<b>18010150</b>	<b>18020150</b>	<b>18040150</b>	1500	30x1.0	1	<b>34,00</b>
<b>18010200</b>	<b>18020200</b>	<b>18040200</b>	2000	30x1.0	1	<b>41,00</b>

**Mesure de circonférence**

- Acier ressort inoxydable
- Graduation gravée à l'acide
- Vernier 0.1 mm

**Omtrekmeetlat**

- Veerstaal uit inox
- Schaalverdeling gegraveerd d.m.v. zuur
- Aflezing 0.1 mm



REF.	Circonférence Cirkel	Diamètre Diameter	Section Sectie	V.E.	€
<b>181601</b>	60 - 950	20 - 300	16x0.20	1	<b>97,00</b>
<b>181602</b>	940 - 2200	300 - 700	16x0.20	1	<b>121,00</b>
<b>181603</b>	2190 - 3460	700 - 1100	16x0.20	1	<b>151,00</b>



**Ruban métrique adhésif**

- Ruban en acier recouvert de polyamide
- Graduation résistante à l'usure
- Pour bancs de travail, bâtis de machines...

**Metrische kleefband**

- Staalband omgeven door polyamide
- Graduatie is slijtagevrij
- Voor werkbanken, machinebouw ...

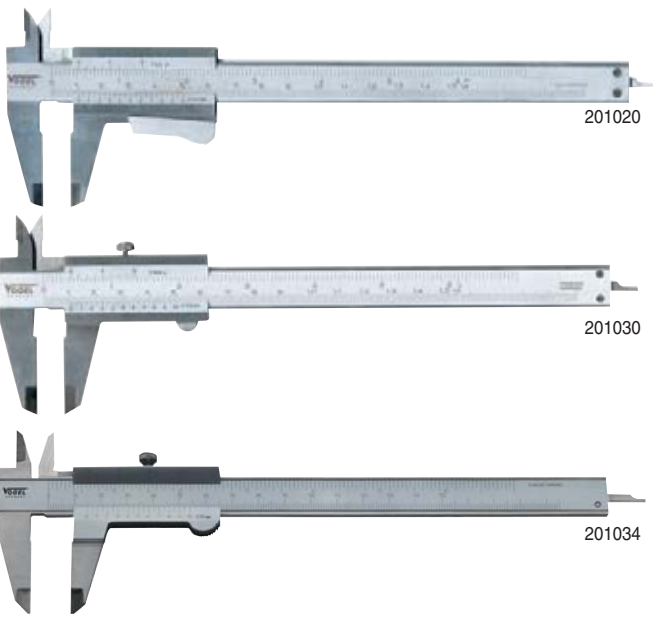
REF.	Section Sectie mm	Longueur Lengte mm	V.E.	€
<b>11310200</b>	13x0.5	2000	1	<b>43,50</b>
<b>11310400</b>	13x0.5	4000	1	<b>70,70</b>



**Pieds à coulisse à vernier**

- Acier inoxydable trempé
- Graduation et vernier, chromés satinés
- Bec finement poli 40mm
- Vernier monobloc 1/20 - 1/128
- 4 fonctions avec jauge de profondeur plate
- Livré en pochette

**Schuifmaten met nonius**

- Gehard inoxstaal
- Schaalverdeling en nonius satijn verchromd
- Bekken fijn gepolijst 40mm
- Nonius uit één stuk gefreesd 1/20 - 1/128
- 4 functies met dieptemaat in vlakke uitvoering
- Geleverd in zakje

Blocage par pouce Momentverstelling	Blocage à vis Vaststelknop	Capacité Meetbereik Mm/Inch	€
<b>201020</b>	<b>201030</b>	150/6"	<b>33,80</b>
<b>201024</b>	<b>201034</b>	200/8"	<b>73,20</b>

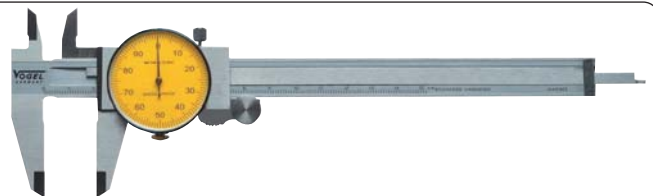

**Pied à coulisse à cadran**

- Acier inoxydable trempé - Poussoir à roulette
- Cadran antichoc

**Schuifmaat met meetklok**

- Gehard inoxstaal - Met duwwieltje
- Schokbestendige meetklok

REF.	Capacité Meetbereik	Lecture Aflezing	Bec Bekken	€
<b>201101</b>	150 mm	0.01	40 mm	<b>98,00</b>



**Pieds à coulisse d'atelier**

- Acier inoxydable trempé
- Echelle graduée et vernier, chromés satinés
- Vernier monobloc 1/20 - 1/128
- Bec poli avec pointes calibrées pour mesures intérieures

**Schuifmaat voor werkplaats**

- Gehard inoxstaal
- Schaal en nonius satijn verchromd
- Nonius uit één stuk gefreesd 1/20 - 1/128
- Bekken fijn gepolijst met geijkte punten voor binnenmaat

REF.	Capacité Meetbereik	Bec Bekken	€
<b>203203</b>	300/12"	100mm	<b>172,00</b>
<b>203303</b>	300/12"	100mm	<b>185,00</b>

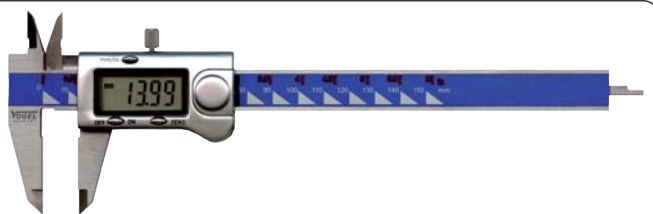

**Pied à coulisse digital**

- Acier inoxydable trempé - Bec finement poli 40mm
- Lecture mm/Inch
- Livré en coffret avec batterie SR44 et mode d'emploi

**Digitale schuifmaat**

- Gehard inoxstaal - Bekken fijn gepolijst 40mm
- Aflezing mm/Inch
- In doos geleverd met batterij SR44 en gebruiksaanwijzing

REF.	Capacité Meetbereik mm/Inch	Lecture Aflezing mm/inch	Précision Nauwkeurigheid	€
<b>202040</b>	150/6"	0.01/0.0005	0.02	<b>81,00</b>
<b>202041</b>	200/8"	0.01/0.0005	0.03	<b>115,00</b>



**Micromètres d'extérieur - Lecture 0.01 mm**

- Tambour et étrier chromes mat
- Tambour Ø 18mm - axe Ø 6.5 mm - pas du filet 0.5 mm
- Touches au carbure - plaque isolante
- Sécurisation de la mesure par levier
- Livré en coffret bois avec clé de réglage

**Buitenmicrometers - Aflezing 0.01 mm**

- Schaaltrommel en huls mat verchroomd
- Trommel Ø 18 mm - schacht 6.5 mm - stijging 5.5 mm
- Hardmetalen toetsen - isolerende plaat
- Klemhendel voor snelle vaststelling
- Geleverd in kistje met afstelsleutel

REF.	Capacité Meetbereik	Lecture Aflezing	Poids Gewicht	€
<b>231351</b>	0 - 25	0.01	360 g	<b>38,00</b>
<b>231352</b>	25 - 50	0.01	425 g	<b>42,00</b>
<b>231353</b>	50 - 75	0.01	630 g	<b>46,00</b>
<b>231354</b>	75 - 100	0.01	810 g	<b>51,00</b>



**Vérificateur d'alésage avec comparateur**

- Touches au carbure
- Comparateur 0 - 10 mm/0.01 mm
- Livré en coffret bois

**Boringmeter met meetklok**

- Hardmetalen toetsen
- Meetklok 0 - 10 mm/0.01 mm
- Geleverd in houten kistje

REF.	Capacité Meetbereik	Lecture Aflezing	Points de contact Contact- punten	Longueur Lengte mm	€
<b>237015</b>	50 - 160	0.01	8	200	<b>148,00</b>



**Comparteurs**

- Boîtier en acier chromé satiné
- Tige et touche en acier inoxydable trempé
- Livré en boîte

**Meetklok**

- Kast uit staal, satijn verchroomd
- Schacht en toets uit roestvrijstaal, gehard
- Geleverd in doosje

REF.	Capacité Meetbereik	Lecture Aflezing	Antichoc Schokvrij	Ø	Poids Gewicht	€
<b>241101</b>	0 - 10.0	0.01	Non - Neen	60	200 g	<b>57,00</b>
<b>241131</b>	0 - 10.0	0.01	Oui - Ja	60	200 g	<b>80,00</b>



**Supports magnétiques universels**

- Colonne chromée
- Base magnétique avec interrupteur ON/OFF
- Prisme finement poli
- Logement du porte comparateur Ø 6 et 8 mm
- Livré en boîte carton

**Universele magneethouder**

- Verchroomde stang
- Magnetische basis met ON/OFF schakelaar
- Prisma fijn gepolijst
- Meetklok-schachtboring Ø 6 en 8 mm
- Geleverd in kartonnen doos

REF.	Hauteur tot. Tot. hoogte	Ø colonne + H Ø stang + H	Bras Arm	Base Basis	Filet colonne Stang draad	Puissance magnétique Magneet kracht	Poids Gewicht	€
<b>252001</b>	240 mm	12x180 mm	140	65x50x55 mm	M 8	55 Kp	1410 g	<b>32,50</b>
<b>252002</b>	280 mm	16x225 mm	180	65x50x55 mm	M 10	55 Kp	1880 g	<b>41,00</b>
<b>250201</b>	295 mm	16x230 mm	250	70x45x65 mm	M 10	60 Kp	2300 g	<b>103,00</b>

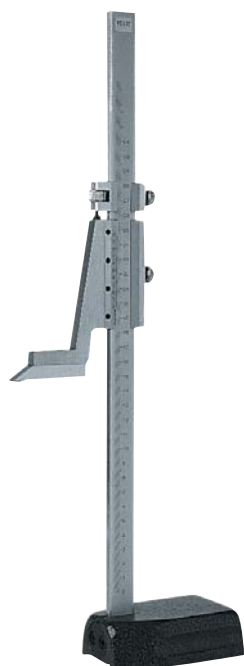

**Trusquin pour atelier mécanique**

- Règle en acier inoxydable
- Graduation et vernier chromés satiné
- Pointe au carbure, interchangeable
- En position "0", la pointe coïncide exactement avec la base
- Base en fonte peinte
- Livré en coffret bois

**Hoogtemeter met traceerpunt**

- Meetlat uit roestvrij staal
- Schaalverdeling en nonius satijn verchroomd
- Hardmetaal-traceerpunt - omwisselbaar
- Bij "0" stelling valt het traceerpunt precies samen met het grondvlak
- Basis uit gietijzer
- Geleverd in houten doos

REF.	Capacité Meetbereik	Vernier Nonius	Poids Gewicht	€
<b>341110</b>	300 mm	0.02	2300 g	<b>146,00</b>
<b>341197</b>	Pointe de rechange / Vervangpunt			<b>15,00</b>

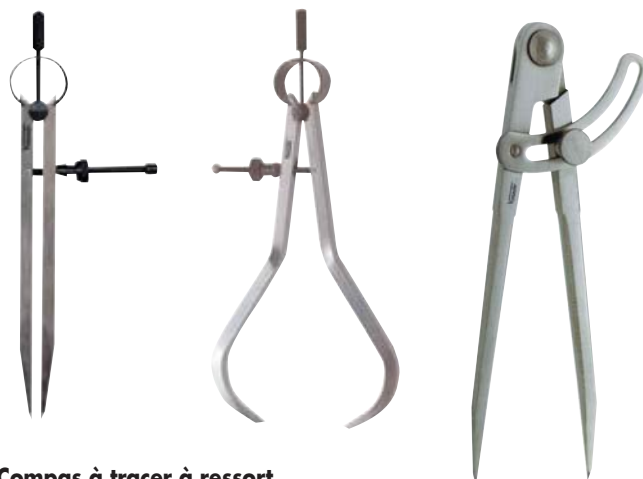

**Compas à tracer à ressort**

- En acier avec pointes trempées
- Jambes à section carrée et écrou de blocage pour réglage fin

**Veercirkel**

- Uit staal, met geharde punten
- Vierkanten benen en snelspanmoer met fijnregeling

**Compas d'épaisseur à ressort**

- En acier avec jambes de section carrée
- Ecrou de blocage pour réglage fin

**Veerdiktemeetpasser**

- Uit staal, met vierkante benen
- Snelspanmoer met fijnregeling

**Compas à tracer avec arc de cercle**

- En acier avec pointes trempées
- Jambes à section carrée, avec rivet

**Cirkels met stelboog**

- Uit staal met geharde punten
- Vierkanten benen met rivet

Mm	Compas à tracer Punt cirkel REF.	€	Compas d'épaisseur Buiten passer REF.	€	Compas avec arc de cercle Puntcirkel m/stelboog REF.	€
150	302422	<b>8,40</b>	302462	<b>8,10</b>	302412	<b>10,20</b>
200	302424	<b>10,90</b>	302464	<b>10,70</b>	302414	<b>13,50</b>
250	302425	<b>14,30</b>	302465	<b>13,70</b>	302415	<b>15,40</b>
300	302426	<b>16,50</b>	302466	<b>16,00</b>	302416	<b>21,00</b>



**Pointes à tracer / Kraspen**

REF.	Description / Beschrijving	€
<b>334604</b>	Acier chrome-vanadium Pointe droite et pointe pliée Uit chroom-vanadium staal Rechte en gebogen punt	<b>2,05</b>
<b>334608</b>	Section hexagonale avec clip Pointe carbure 6-kantige sectie met clip Geharde punt	<b>2,50</b>
<b>334610</b>	Boîtier hexagonal en aluminium à bouton poussoir 6-kantig doosje uit aluminium met drukknoop	<b>14,20</b>
<b>334613</b>	Boîtier en metal, style stylo à bouton poussoir Doosje uit metaal, balpente met drukknoop	<b>13,70</b>

**Règle à tracer**

- Acier inoxydable trempé
- Graduation gravée - Finition chromé satiné

**Afschrijflineaal**

- Uit roestvrijstaal, gehard
- Schaalverdeling gegraveerd en satijn verchromd

REF.	Longueur Lengte	Poids Gewicht	€
<b>336220</b>	200 mm	420 g	<b>37,20</b>
<b>336221</b>	250 mm	450 g	<b>41,30</b>
<b>336223</b>	300 mm	500 g	<b>46,00</b>

**Latte graduée en aluminium**

- Graduation noire et rouge
- Face arrière antidérapante

**Gegradueerde meetlat uit aluminium**

- Graduatie zwart en rood
- Achterzijde anti-slip

REF.	Section Sectie	Longueur Lengte	V.E.	€
<b>963030</b>	35x1.5	300 mm	10	<b>6,30</b>
<b>963060</b>	35x1.5	600 mm	10	<b>11,80</b>
<b>963100</b>	35x1.5	1000 mm	10	<b>20,70</b>

**Règle à filament – Précision DIN 874/00**

- Acier inoxydable trempé et rectifié
- Poignée isolante

**Precisie haarlineaal volgens DIN 874/00**

- Uit roestvrijstaal, gehard en gereficeerd
- Met isolerende greep

REF.	Longueur Lengte	Poids Gewicht	€
<b>310303</b>	100 mm	80 g	<b>24,90</b>
<b>310306</b>	200 mm	160 g	<b>40,90</b>
<b>310308</b>	300 mm	240 g	<b>78,60</b>
<b>310311</b>	500 mm	400 g	<b>157,00</b>

**Equerres de précision  
DIN 875/II**

- Acier spécial finement poli

**Precisie winkelhaken volgens  
DIN 875/II**

- Uit speciaal staal fijngeslepen

**Equerre à talon et lame fine  
DIN 875/II**

- Acier spécial finement poli

**Blokwinkelhaak en fijn blad  
DIN 875/II**

- Uit speciaal staal fijngeslepen

Dimensions Afmetingen Mm	Equerre simple Winkelhaak REF.	€	Equerre à talon Met aanslag REF.	€
150 x 100	310063	<b>18,10</b>	310163	<b>29,10</b>
200 x 130	310064	<b>27,00</b>	310164	<b>36,10</b>
250 x 165	310065	<b>38,70</b>	310165	<b>50,50</b>
300 x 175	310066	<b>48,40</b>	310166	<b>61,90</b>
500 x 250	310067	<b>103,40</b>	310167	<b>143,00</b>
750 x 375	310068	<b>128,60</b>	310168	<b>190,00</b>
1000x 200	310069	<b>177,00</b>	310169	<b>244,00</b>

Dimensions Afmetingen	REF.	Poids Gewicht	€
100 x 70	<b>312353</b>	140 g	<b>21,60</b>
150 x 100	<b>312354</b>	340 g	<b>25,80</b>
200 x 130	<b>312355</b>	540 g	<b>30,00</b>
250 x 160	<b>312356</b>	850 g	<b>38,00</b>
300 x 175	<b>312357</b>	1750 g	<b>42,30</b>



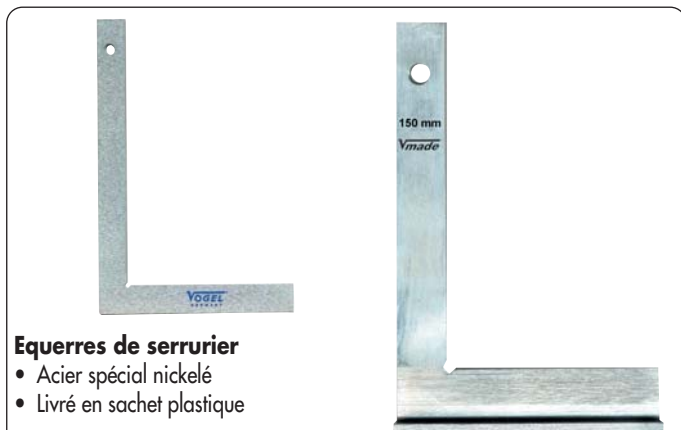

**Equerres de serrurier**

- Acier spécial nickelé
- Livré en sachet plastique

**Slotenmakers winkelhaak**

- Uit speciaalstaal, vernikkeld
- Geleverd in zakje

Dimensions Afmetingen Mm	Equerre simple Winkelhaak REF.	€	Equerre à talon Met aanslag REF.	€
100 x 70	312453	<b>5,40</b>	312473	<b>8,80</b>
150 x 100	312454	<b>6,00</b>	312474	<b>10,10</b>
200 x 130	312455	<b>8,50</b>	312475	<b>13,60</b>
250 x 160	312456	<b>8,80</b>	312476	<b>16,80</b>
300 x 175	312457	<b>9,70</b>	312477	<b>20,40</b>
400 x 230	312458	<b>12,10</b>	312478	<b>26,90</b>
500 x 280	312459	<b>15,10</b>	312479	<b>33,40</b>
600 x 330	312460	<b>20,30</b>	312480	<b>46,00</b>
750 x 375	312461	<b>24,50</b>	312481	<b>54,70</b>
1000 x 500	312462	<b>33,50</b>	312482	<b>69,80</b>



**Equerres à lame acier et base aluminium**

- Lame en acier trempé avec graduation sur les quatre côtés
- Base coupée en onglet
- Section 40 x 1 mm

**Winkelhaak met stalen meetlat en basis uit aluminium**

- Lat uit gehard staal met schaalverdeling op vier zijden
- Basis in verstek gezaagd (45°)
- Sectie 40 x 1 mm

Dimensions Afmetingen Mm	Acier Staal REF.	€	Inox Roestvrij REF.	€
200 x 130	504032	<b>15,30</b>	504062	<b>18,70</b>
250 x 145	504033	<b>16,70</b>	504063	<b>20,00</b>
300 x 145	504034	<b>18,00</b>	504064	<b>21,10</b>
400 x 170	504036	<b>21,20</b>	504066	<b>24,70</b>

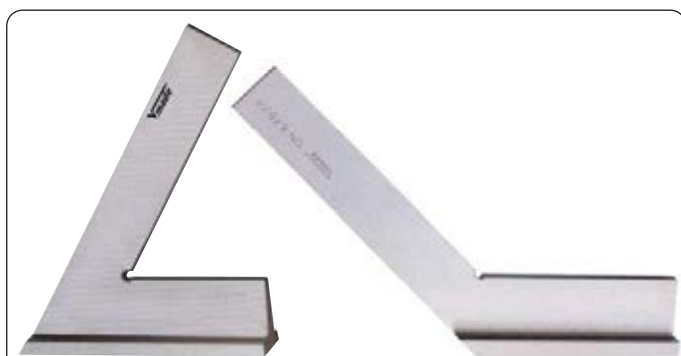

**Equerre 45° à chapeau  
Zwaaishaak 45° met aanslag**

**Equerre 135° à chapeau  
Zwaaishaak 135° met aanslag**

REF.	Dimensions Afmetingen	€
<b>313023 - 45°</b>	150 x 100 mm	<b>51,00</b>
<b>313024 - 45°</b>	200 x 130 mm	<b>63,60</b>
<b>313082 - 135°</b>	150 x 100 mm	<b>34,80</b>
<b>313083 - 135°</b>	200 x 130 mm	<b>47,00</b>

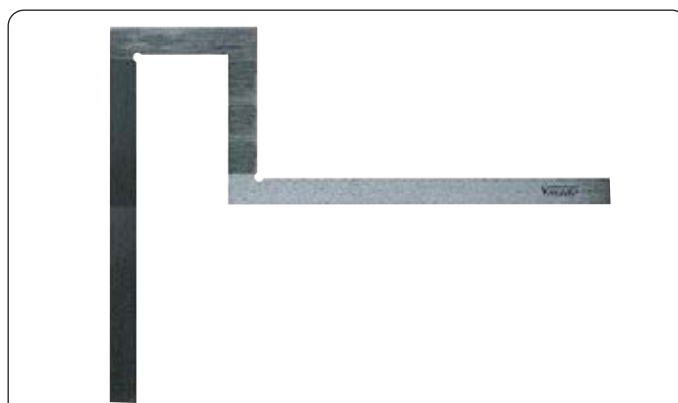

**Equerre à brides en acier nickelé  
Flens winkelhaak uit vernikkeld staal**

REF.	Dimensions Afmetingen	Section Sectie	Poids Gewicht	€
<b>312511</b>	300 x 300 mm	30x6	750 g	<b>22,50</b>
<b>312512</b>	400 x 400 mm	30x6	1100 g	<b>30,50</b>

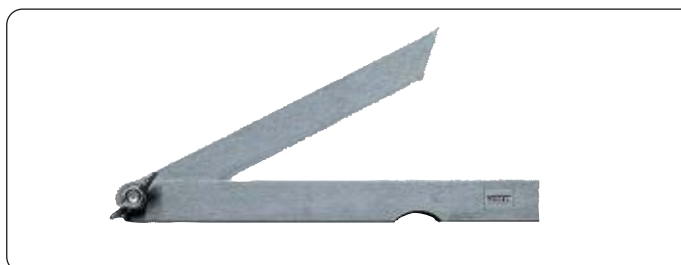

**Equerre réglable en acier chromé  
Verstelbare winkelhaak uit verchromde staal**

REF.	Longueur Lengt	€
<b>312573</b>	200 mm	<b>12,00</b>
<b>312574</b>	250 mm	<b>16,90</b>
<b>312575</b>	300 mm	<b>22,00</b>
<b>312576</b>	400 mm	<b>28,80</b>



**Equerre de menuisier réglable**

- Lame en acier trempé de section 30 x 1.8 mm
- Poignée en aluminium anodisé de section 30 x 5mm
- Marquage des angles sur la poignée

**Verstelbare schrijnwerkers winkelhaak**

- Blad uit gehard staal, sectie 30 x 1.8 mm
- Geanodiseerde alu-greep, sectie 30 x 5mm
- Met hoekgraduatie op de greep

REF.	Longueur Lengte	€
<b>504853</b>	250 mm	<b>18,50</b>



**Rapporteur d'angle universel**

- Acier inoxydable trempé et finement poli
- Graduation chromée satinée
- Lecture du vernier, sans parallaxe et avec loupe
- Lecture 4x90° - Graduation 1/12° = 5"
- 3 longueurs de guide: 150/200/300 mm
- Livré en boîte plastique

**Universele hoekmeter**

- Uit roestvrij staal, gehard en fijngeslepen
- Schaalverdeling satijn verchromd
- Parallaxvrije aflezing van de nonius, met loep
- Aflezing 4x90° - Schaalverdeling 1/2° = 5"
- Met 3 meetregels: 150/200/300 mm
- Geleverd in plastieken kistje

REF.	Poids Gewicht	€
<b>321220</b>	1100 g	<b>158,00</b>



**Rapporteur avec vis de blocage**

- Acier spécial entièrement chromé
- Graduation chromé mat

**Hoekmeter met vaststelmoer**

- Uit speciaalstaal volledig verchromd
- Schaalverdeling mat verchromd

REF.	Tige Schacht	Arc Boog	Poids Gewicht	€
<b>322511</b>	120 mm	80 mm	65 g	<b>27,50</b>
<b>322512</b>	150 mm	120 mm	125 g	<b>28,70</b>
<b>322513</b>	200 mm	150 mm	180 g	<b>35,00</b>
<b>322514</b>	300 mm	200 mm	350 g	<b>49,10</b>
<b>322515</b>	500 mm	300 mm	560 g	<b>106,50</b>
<b>322516</b>	600 mm	300 mm	675 g	<b>119,00</b>



**Rapporteur à règle coulissante**

- Acier spécial entièrement chromé
- Graduation chromé mat

**Hoekmeter met verstelbaar liniaal**

- Uit speciaalstaal volledig verchromd
- Schaalverdeling mat verchromd

REF.	Tige Schacht	Arc Boog	Poids Gewicht	€
<b>320572</b>	300 mm	150 mm	250 g	<b>53,00</b>
<b>320573</b>	400 mm	200 mm	420 g	<b>64,80</b>
<b>320574</b>	500 mm	250 mm	1000 g	<b>93,00</b>
<b>320575</b>	600 mm	300 mm	1350 g	<b>118,50</b>

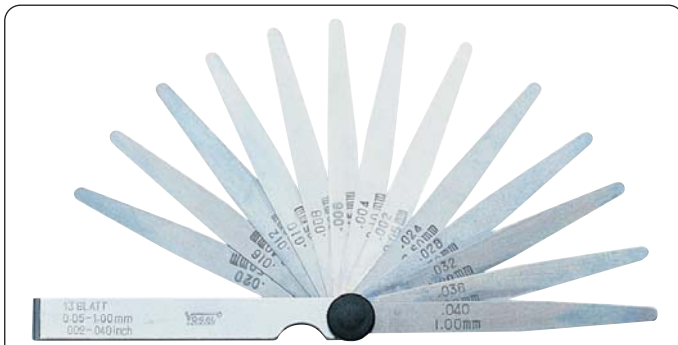

**Jauges d'épaisseur**

- Longueur des lames 100 mm
- Acier ressort trempé
- Boîtier nickelé

**Voelermaten-set**

- Bladlengte 100 mm
- Uit veerstaal, gehard
- Doosje vernikkeld

REF.	Lames Blad	Capacité Meetbereik	€
<b>411005</b>	13	0.05 - 1.00 mm .002 - .020 inch	<b>3,40</b>
<b>411007</b>	20	0.05 - 1.00 mm .002 - .040 inch	<b>5,60</b>
<b>Acier inoxydable / Roestvrijstaal</b>			
<b>413107</b>	20	0.05 - 1.00 mm .002 - .040 mm	<b>15,80</b>
<b>Laiton antimagnétique / Uit antimagnetische messing</b>			
<b>414007</b>	20	0.05 - 1.00 mm	<b>33,50</b>

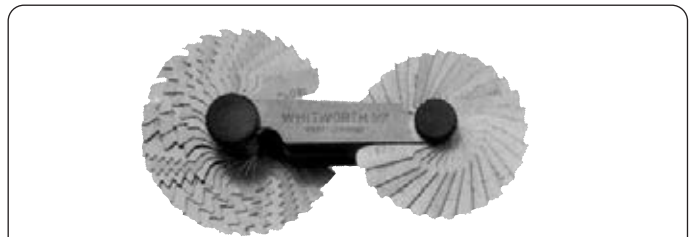

**Jauges à filet - intérieur et extérieur  
Schroefdraadmeters voor binnen en buiten**

REF.	Nb. lames Bladen	Capacité Meetbereik	Filet Draad	€
<b>471009</b>	24	0.25 - 6.00 mm	metr. 60°	<b>4,30</b>
<b>471014</b>	52	0.25 - 6.00 mm	ww/metr.	<b>6,20</b>



**Loupe sur pied avec échelle de mesure**

- Lentille réglable
- Echelle de mesure en acier inoxydable

**Vergrootglas op voet met schaalverdeling**

- Regelbare lens
- Schaalverdeling in roestvrij staal

REF.	Lentille Lens	Grossissement Vergroting	€
<b>600178</b>	Ø 20 mm	10 x	<b>145,00</b>



**Bandes d'épaisseur en laiton - 2500 x 150 mm  
Voelerbanden uit messing - 2500 x 150 mm**

REF.	Epaisseur Dikte	€	REF.	Epaisseur Dikte	€
<b>462025</b>	0.025	<b>36,40</b>	<b>462150</b>	0.150	<b>52,80</b>
<b>462050</b>	0.050	<b>34,70</b>	<b>462200</b>	0.200	<b>62,30</b>
<b>462075</b>	0.075	<b>38,70</b>	<b>462250</b>	0.250	<b>69,50</b>
<b>462100</b>	0.100	<b>43,50</b>	<b>462300</b>	0.300	<b>79,40</b>

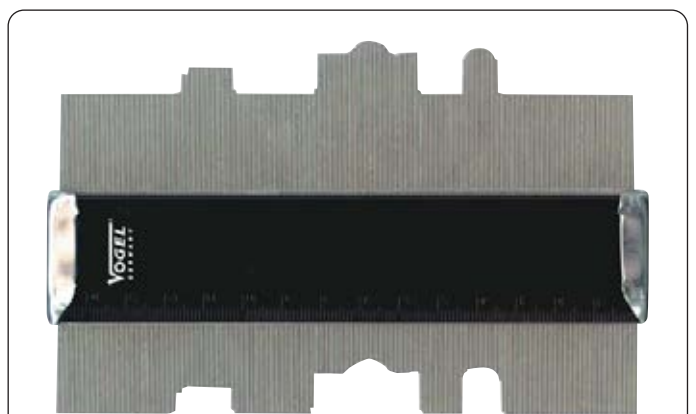

**Gabarit multiforme**

- Aiguilles en acier trempé

**Profielmal**

- Geharde stiften

REF.	Dimensions Afmetingen	€
<b>474502</b>	300 x 75	<b>92,00</b>



## EASY

- Coque en plastique ABS antichoc
  - Cadre robuste en aluminium
  - Deux fermetures à clé, plus une fermeture à combinaison
  - Poignée confortable
  - Porte-documents A4 dans le couvercle
  - Rangement des outils sur deux plateaux
  - Compartiment du fond modulable
- *Schelp in schokbestendig ABS-plastic*
  - *Kader in robuust aluminium*
  - *Twee sloten met sleutel, plus één slot met cijfercombinatie*
  - *Comfortabel handvat*
  - *Vak voor documenten A4 in het deksel*
  - *Twee platen voor het opbergen van gereedschappen*
  - *Moduleerbaar vak voor grote stukken*

Mesures intérieures  
*Binnenmaten*  
455 x 345 x 160 mm

Mesures extérieures  
*Buitenmaten*  
495 X 410 X 175 mm

Poids  
*Gewicht*  
5.7 kg

Volume  
26.0 L

Capacité de charge  
*Laadvermogen*  
Max 25 kg



114.02/P

**EASY-POCKET**

€ 150,00

- Plateau amovible dans le couvercle avec 22 poches
  - Plateau amovible dans le compartiment du bas avec 15 poches
- *Uitneembare plaat in het deksel met 22 zakken*
  - *Uitneembare plaat in het grondvak met 15 zakken*



114.02/M

**EASY-MODULE**

€ 170,00

- Plateau amovible dans le couvercle avec 2 x 3 modules pour outils de Ø max 21 mm
  - Plateau amovible dans le compartiment du bas avec 3 modules pour outils de Ø max 28 mm
- *Uitneembare plaat in het deksel met 2 x 3 modules voor gereedschappen van Ø max 21 mm*
  - *Uitneembare plaat in het grondvak met 3 modules voor gereedschappen van Ø max 28 mm*

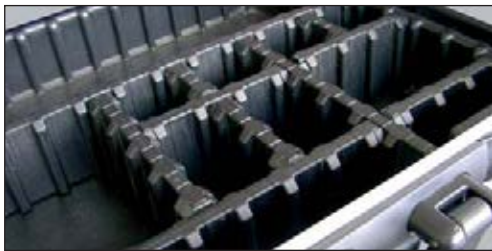

## EASY

- Valise spacieuse sur roues , avec manche télescopique
  - Coque en plastique ABS antichoc
  - Cadre robuste en aluminium
  - Deux fermetures à clé, plus une fermeture à combinaison
  - Poignée confortable
  - Porte-documents A4 dans le couvercle
  - Rangement des outils sur deux plateaux
  - Compartiment du fond modulable
- *Ruime koffer op wielen, met uitschuifbaar handvat*
  - *Schelp in schokbestendig ABS-plastic*
  - *Kader in robuust aluminium*
  - *Twee sloten met sleutel, plus één slot met cijfercombinatie*
  - *Comfortabel handvat*
  - *Vak voor documenten A4 in het deksel*
  - *Twee platen voor het opbergen van gereedschappen*
  - *Moduleerbaar vak voor grote stukken*

Mesures intérieures  
Binnenmaten  
485 x 350 x 195 mm

Mesures extérieures  
Buitenmaten  
500 X 430 X 270 mm

Poids  
Gewicht  
8.0 kg

Volume  
36.0 L

Capacité de charge  
Laadvermogen  
Max 30 kg



**114.04/P**

**RUN-POCKET**

€ **220,00**

- Plateau amovible dans le couvercle avec 22 poches
  - Plateau amovible dans le compartiment du bas avec 15 poches
- *Uitneembare plaat in het deksel met 22 zakken*
  - *Uitneembare plaat in het grondvak met 15 zakken*



**114.04/M**

**RUN-MODULE**

€ **240,00**

- Plateau amovible dans le couvercle avec 2 x 3 modules pour outils de Ø max 18 mm
  - Plateau amovible dans le compartiment du bas avec 3 modules pour outils de Ø max 21 mm
- *Uitneembare plaat in het deksel met 2 x 3 modules voor gereedschappen van Ø max 18 mm*
  - *Uitneembare plaat in het grondvak met 3 modules voor gereedschappen van Ø max 21 mm*



## JET

- Coque en plastique ABS High-Impact
- Hermétique à l'eau, à la poussière, à l'air
- Résistance aux températures extrêmes (-40° jusqu'à +80° C)
- Valve de compensation de la pression de l'air
- Oeillets pour cadenas
- Porte-documents dans le couvercle
- Plateau amovible avec 21 poches
- Plateau du bas amovible avec 14 poches
- Compartiment du fond modulable

- Schelp in ABS-plastic High-Impact
- Stofdicht, luchtdicht, waterdicht
- Temperatuurstabiel -40° to +80° C
- Luchtdrukkelijkmakings ventiel
- Oogjes voor hangslot
- Uitneembare plaat met 21 zakken in de deksel
- Uitneembare plaat met 14 zakken in het grondvak
- Moduleerbaar vak voor grote stukken

114.17/P JET

€ 190,00

Mesures intérieures  
Binnenmaten  
420 x 350 x 168 mm

Mesures extérieures  
Buitenmaten  
450 x 375 x 185 mm

Poids  
Gewicht  
5.7 kg

Volume  
25.0 L

Capacité de charge  
Laadvermogen  
50 kg



## JUMBO

- Coque en plastique ABS High-Impact
- Hermétique à l'eau, à la poussière, à l'air
- Résistance aux températures extrêmes (-40° jusqu'à +80° C)
- Valve de compensation de la pression de l'air
- Oeillets pour cadenas
- Porte-documents A4 dans le couvercle
- Plateau amovible dans le couvercle avec 23 poches
- Plateau amovible dans le compartiment du bas avec 14 poches
- Compartiment du fond modulable

- Schelp in ABS-plastic High-Impact
- Stofdicht, luchtdicht, waterdicht
- Temperatuurstabiel -40° tot +80°
- Luchtdrukkelijkmakings ventiel
- Oogjes voor hangslot
- Uitneembare plaat met 23 zakken in het deksel
- Uitneembare plaat met 14 zakken in het grondvak
- Moduleerbaar vak voor grote stukken

114.19/P JUMBO-POCKETS

€ 308,00

Mesures intérieures  
Binnenmaten  
535 x 360 x 195 mm

Mesures extérieures  
Buitenmaten  
595 x 440 x 235 mm

Poids  
Gewicht  
9.8 kg

Volume  
38.0 L

Capacité de charge  
Laadvermogen  
50 kg





## SHARK

- Coque en HPDE pratiquement indestructible
- Cadre robuste en aluminium
- Deux fermetures à clé, plus une fermeture à combinaison
- Porte-documents A4 dans le couvercle
- Plateau amovible dans le couvercle avec 22 poches
- Plateau amovible dans le compartiment du bas avec 15 poches
- Compartiment du fond modulable

- *Schelp in HDPE, bijna onverwoestbaar*
- *Stevig kader in aluminium*
- *Twee sloten met sleutel, plus één met cijfercombinatie*
- *Vak voor documenten A4 in het deksel*
- *Uitneembare plaat met 22 zakken in het deksel*
- *Uitneembare plaat met 15 zakken in het grondvak*

**115.03/P SHARK-POCKETS € 270,00**

Mesures intérieures  
Binnenmaten  
475 x 360 x 200 mm

Mesures extérieures  
Buitenmaten  
495 x 430 x 215 mm

Poids  
Gewicht  
6.0 kg

Volume  
35.0 L

Capacité de charge  
Laadvermogen  
30 kg



## RHINO

- Valise spacieuse sur roues avec manche télescopique
- Coque en HDPE pratiquement indestructible
- Cadre robuste en aluminium
- Deux fermetures à clé, plus une fermeture à combinaison
- Porte-documents A4 dans le couvercle
- Deux plateaux amovibles de 23 poches dans le couvercle
- Plateau amovible dans le compartiment du bas avec 15 poches
- Compartiment du bas modulable

- *Ruime koffer op wielen, met uitschuifbaar handvat*
- *Schelp in HDPE, bijna onverwoestbaar*
- *Stevig kader in aluminium*
- *Twee sloten met sleutel, plus één met cijfercombinatie*
- *Vak voor documenten in het deksel*
- *Twee uitneembare platen met 23 zakken in het deksel*
- *Uitneembare plaat met 15 zakken in het grondvak*

**115.04/P RHINO-POCKETS € 340,00**

Mesures intérieures  
Binnenmaten  
455 x 375 x 225 mm

Mesures extérieures  
Buitenmaten  
505 x 440 x 280 mm

Poids  
Gewicht  
7.9 kg

Volume  
46.0 L

Capacité de charge  
Laadvermogen  
35 kg





## JUPITER

- Sacoche en cuir solide aux extrémités renforcées par un profilé d'aluminium anodisé
- Compartiment du fond en acier zingué
- Porte-outils sur le devant, sur le panneau arrière et sur les côtés
- *Tas in stevig leder, de uiteinden met een profiel van anodiseerd aluminium*
- *Bodemcompartiment uit verzinkt staal*
- *Gereedschapshouder op de voorkant, op de achterste plaat en op beide kanten*

**202.02 JUPITER € 115,00**

Mesures intérieures  
Binnenmaten  
420 x 250 x 160 mm

Poids  
Gewicht  
2.8 kg



## PROFI-BAG

- Valise en simili cuir et plastique ABS
- Deux serrures à combinaison
- Nombreuses poches pour un total de 45 outils
- Plateau central amovible

- *Koffer uit kunstleder en ABS plastic*
- *Twee sloten met cijfercombinatie*
- *45 gereedschapshouder*
- *Centraal paneel uitneembaar*

**207.03 PROFI-BAG € 95,00**

Mesures intérieures  
Binnenmaten  
430 x 320 x 190 mm

Poids  
Gewicht  
2.8 kg



## SATURNE

- Sacoche en cuir aux coutures renforcées de rivets
- Porte-outils sur le devant, le milieu et l'arrière
- Bandoulière ajustable et amovible

- *Tas in leder met naden versterkt met klinknagels*
- *Gereedschapshouder op de voor- en de achterkant en in het midden*
- *Verstelbare, verwijderbare draagriem*

**204.04 SATURNE € 99,00**

Mesures intérieures  
Binnenmaten  
220 x 250 x 140 mm

Poids  
Gewicht  
1.1 kg



## TROUSSES À ROULER EN CUIR SYNTHÉTIQUE ROLTASSEN IN KUNSTLEDER

**206.53 15 poches / zakjes € 16,00**

**206.54 20 poches / zakjes € 17,00**

Mesures intérieures  
Binnenmaten

206.53  
680 x 320 mm

206.54  
790 x 320 mm





## CARRY

- Manufacturé en nylon épais à l'épreuve des déchirures
- Fermeture par tirette double de haute qualité
- Base du sac renforcé et protégé de l'eau
- Nombreuses poches et attaches pour le rangement d'outils et d'accessoires.

- *Gemaakt van dik nylon en dus zeer scheurvast*
- *Dubbele hoge kwaliteit ritssluiting*
- *Basis van de tas is versterkt en waterbestendig*
- *Talrijke zakjes en banden voor het opbergen van gereedschap en toebehoren*

**116.03 CARRY € 63,00**

Mesures intérieures  
Binnenmaten  
390 x 195 x 285 mm

Mesures extérieures  
Buitenmaten  
400 x 200 x 290 mm

Poids  
Gewicht  
0.95 kg

Capacité de charge  
Laadvermogen  
12 kg



## WORK

- Manufacturé en nylon épais à l'épreuve des déchirures
- Poignée solide en métal + courroie de transport
- Base du sac renforcé et protégé de l'eau
- Nombreuses poches et attaches pour le rangement d'outils et d'accessoires.

- *Gemaakt van dik nylon en dus zeer scheurvast*
- *Stevig handvat uit metaal + draagriem*
- *Basis van de tas is versterkt en waterbestendig*
- *alrijke zakjes en banden voor het opbergen van gereedschap en toebehoren*

**116.04 WORK € 71,00**

Mesures intérieures  
Binnenmaten  
400 x 190 x 240 mm

Mesures extérieures  
Buitenmaten  
450 x 250 x 270 mm

Poids  
Gewicht  
2.00 kg

Capacité de charge  
Laadvermogen  
12 kg



## SERVICE

- Manufacturé en nylon épais à l'épreuve des déchirures
- Fermeture par tirette double de haute qualité
- Base du sac renforcé et protégé de l'eau
- Compartiment pour laptop et porte-documents
- Nombreuses poches pour le rangement d'outils et de petites pièces. + plateau amovible à l'arrière

- *Gemaakt van dik nylon en dus zeer scheurvast*
- *Dubbele hoge kwaliteit ritssluiting*
- *Basis van de tas is versterkt en waterbestendig*
- *Compartiment voor laptop met documentenvak*
- *Talrijke zakjes voor het opbergen van gereedschap en kleine stukken + uitneembare plaat in de achterkant*

**116.01 SERVICE € 73,00**

Mesures intérieures  
Binnenmaten  
440 x 320 x 180 mm

Mesures extérieures  
Buitenmaten  
450 x 340 x 200 mm

Poids  
Gewicht  
2.70 kg

Capacité de charge  
Laadvermogen  
12 kg



## MOVE

- Manufacturé en nylon épais à l'épreuve des déchirures
- Courroies pour le port sur le dos ou sur l'épaule
- Base du sac renforcé et protégé de l'eau
- Fermeture à tirette double de haute qualité
- Compartiment pour laptop
- Nombreuses poches pour le rangement d'outils et de petites pièces + plateau amovible à l'avant

- *Gemaakt van dik nylon en dus zeer scheurvast*
- *Draagriemen om op rug of schouder te dragen*
- *Dubbele hoge kwaliteit ritsluiting*
- *Basis van de tas is versterkt en waterbestendig*
- *Compartiment voor laptop*
- *Talrijke zakjes voor het opbergen van gereedschap en kleine stukken + uitneembare plaat in de voorkant*

Mesures extérieures  
Buitenmaten  
350 x 430 x 200 mm

Poids  
Gewicht  
2.30 kg

Capacité de charge  
Laadvermogen  
12 kg

**116.02      MOVE      €    70,00**



## MOTION

- Manufacturé en nylon épais à l'épreuve des déchirures
- Monté sur roues. Poignée télescopique
- Poignée ergonomique + courroie pour épaule
- Grand compartiment pour laptop à l'avant
- Porte-documents + plateau à poches pour outils
- Compartiment spacieux pour petites pièces

- *Gemaakt van dik nylon en dus zeer scheurvast*
- *Op wielen; uitschuifbaar handvat*
- *Ergonomisch handvat + draagriem om op schouder te dragen*
- *Groot vak voor laptop in de voorkant*
- *Vak voor documenten + Plaat met zakjes voor gereedschap*
- *Ruie vak voor kleine stukken*

Mesures extérieures  
Buitenmaten  
460 x 340 x 200 mm

Poids  
Gewicht  
3.10 kg

Capacité de charge  
Laadvermogen  
12 kg

**116.05      MOTION      €    198,00**

Serre-joints  
*Lijmtangen*



Sauterelles  
*Snelspanners*

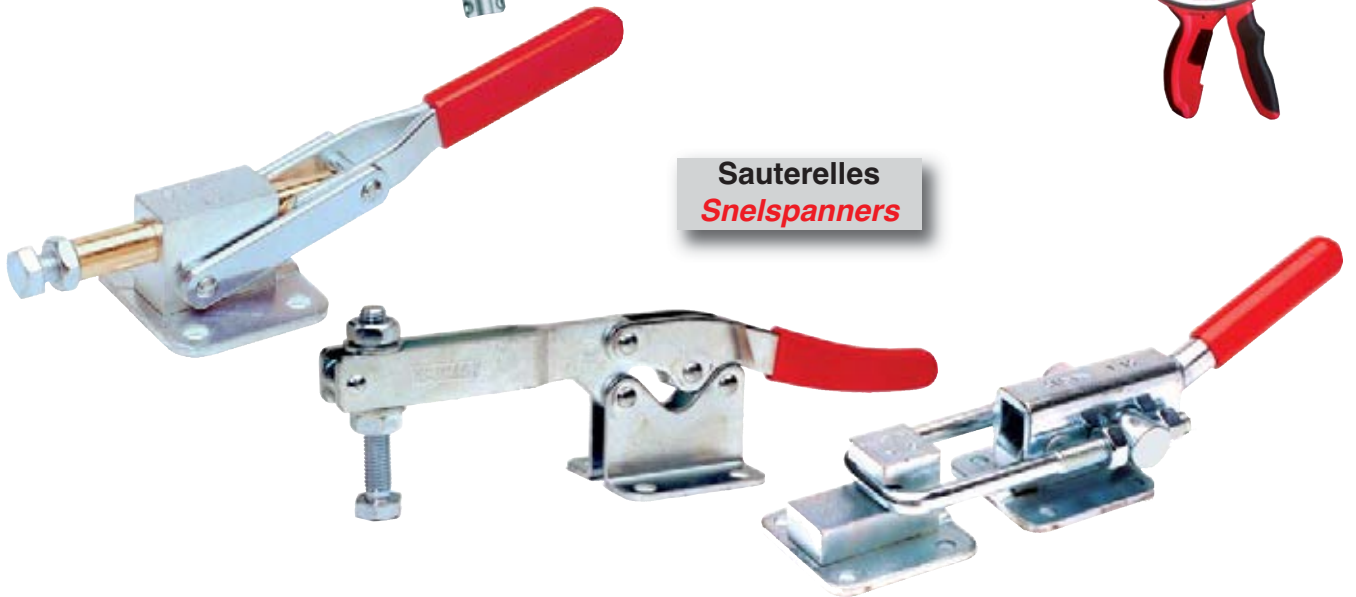

Pinces de soudeur  
*Las-griptang*



Pinces de serrage rapide  
*Snel-klemtangen*

